

Methodology in Phylogenetics

Joseph Crisp

BBSRC funded PhD Student

Rowland Kao

Ruth Zadoks

j.crisp.1@research.gla.ac.uk

Next Generation Sequencing Platforms

- Cheap and fast alternatives to Sanger sequencing methods
- Prone to error production
- Provides a huge amount of data that can be used to establish the validity of variation observed



illumina®



Roche
454
SEQUENCING



ion torrent



SOLID™



Oxford
NANOPORE
Technologies®

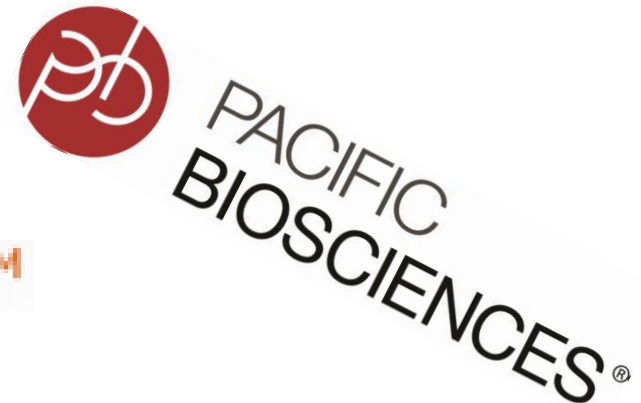

PACIFIC
BIOSCIENCES®

FASTQ File

```
@InstrumentName : RunId : FlowCellId : Lane : TileNumber : X-coord : Y-coord          PairId : Filtered? : Bit
CGCGTTCATGTGCGGCGCCGGCGCTGGTTTCCATCGGTTCGATTTCGGACGGCAAACATCGACCGCAGGATCCGCCGTACCATGTCCGACA
GGCGCCCCTTGGGTAGATTGCCGTTCGGCGTAGGGCGGCACGCAGGCGGACGGAGAGTGCTTCCGAGTGCCACGGCGCTGAATCGATCCG
CGCCGCGCACCTTTGGTCCAGGGCGGCCAGCGCGCACTCCCAGCTGGGTGTTTCGGCCCCATCCGCACTCACCC
+
1>1>>AA1@333AA11AE00AEAE///FH0BFFGB/E/?/>FHH/B//>EEGE0>0BGE0>//E/C//1<C?AFC///<FGF1?1?C?-<FF-@??-
C./CGG0:0C0;C0-.;C-?A@--.:?-@-@B@<@=-9--9---;.-9///;///-----/;/9----9;99///;-9----@;-9-;9-9-;///B-9/B/9-;9@--@AE@@@-;-
;-BB-9/-//;A9-;B-/-----9-----//;--
```

FASTQC

The screenshot shows the FastQC application window. The title bar reads 'FastQC'. The menu bar contains 'File' and 'Help'. The main window title is 'AgR111_S8_L001_R1_001.fastq.gz'. On the left, a vertical list of metrics is shown, each with a status icon: a green checkmark for 'Basic Statistics', 'Per sequence GC content', 'Per base N content', 'Sequence Duplication Levels', 'Overrepresented sequences', and 'Adapter Content'; a red 'X' for 'Per base sequence quality', 'Per base sequence content', and 'Kmer Content'; and an orange exclamation mark for 'Sequence Length Distribution'. The right pane is titled 'Basic sequence stats' and contains a table with the following data:

Measure	Value
Filename	AgR111_S8_L001_R1_001.fastq.gz
File type	Conventional base calls
Encoding	Sanger / Illumina 1.9
Total Sequences	556621
Sequences flagged as poor quality	0
Sequence length	35-301
%GC	65

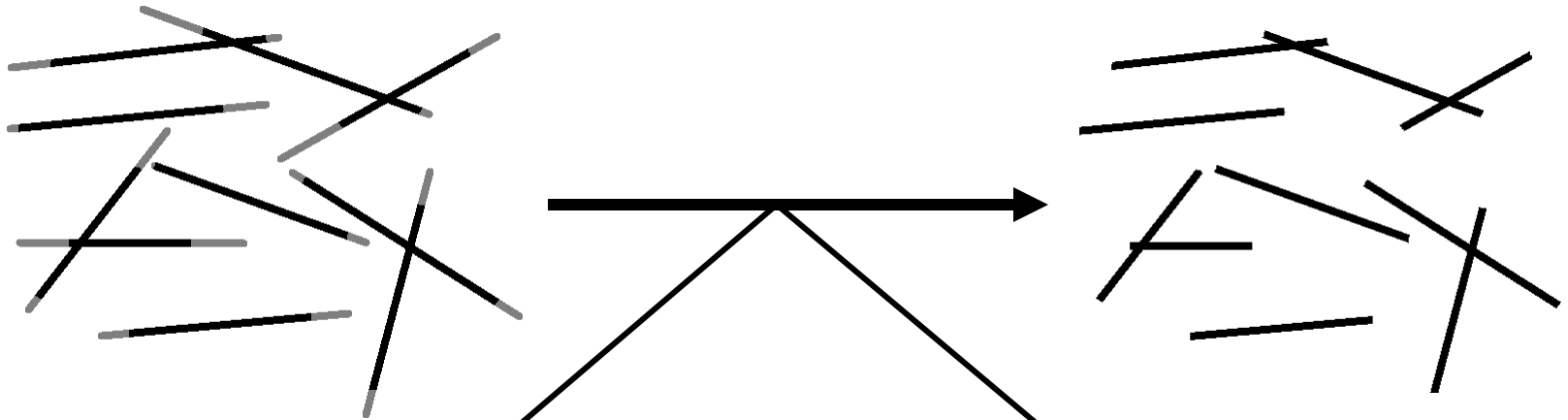

FASTQC

The screenshot shows the FastQC application window. The title bar reads 'FastQC'. The menu bar contains 'File' and 'Help'. The main window title is 'AgR111_S8_L001_R1_001_prinseq_good_7L79.fastq'. On the left, a vertical list of metrics is shown, each with a status icon: a green checkmark for 'Basic Statistics', 'Per base sequence quality', 'Per tile sequence quality', 'Per sequence quality scores', 'Per sequence GC content', 'Per base N content', 'Sequence Duplication Levels', 'Overrepresented sequences', and 'Adapter Content'; and an orange exclamation mark for 'Per base sequence content', 'Sequence Length Distribution', and 'Kmer Content'. The right pane is titled 'Basic sequence stats' and contains a table with the following data:

Measure	Value
Filename	AgR111_S8_L001_R1_001_prinseq_good_7L79.fastq
File type	Conventional base calls
Encoding	Sanger / Illumina 1.9
Total Sequences	494508
Sequences flagged as poor quality	0
Sequence length	50-261
%GC	65

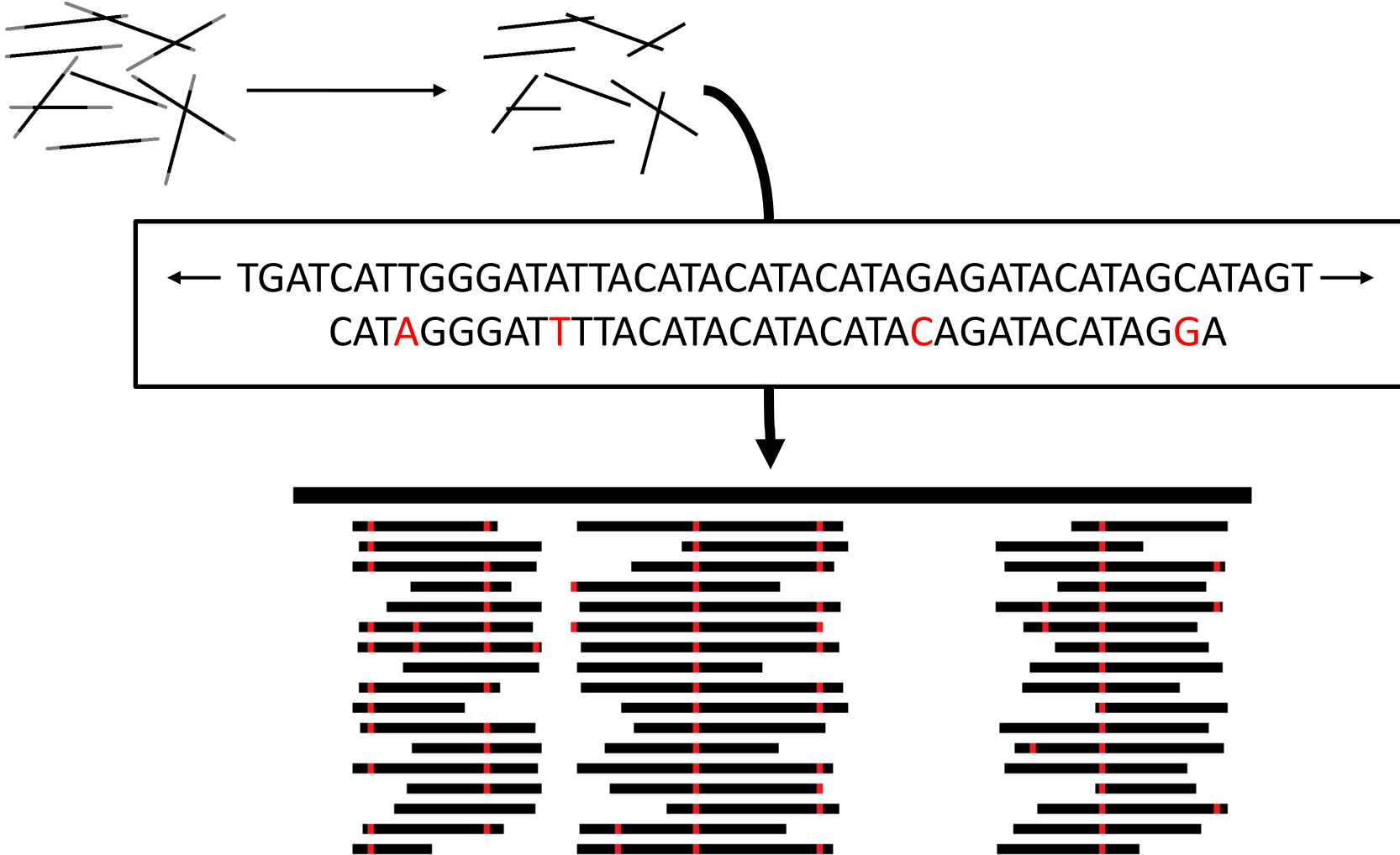

Read Depth

Mapping Quality

High Quality Base Depth

Allele Support



NEXUS File

```
# NEXUS

BEGIN DATA;
DIMENSIONS NTAX=3 NCHAR=40;
FORMAT MISSING=N GAP=- DATATYPE=DNA;
MATRIX;
IsolateId_Year    CGTACGCGTAGCGTGACAGTGCCTAGTTGTGATCTGTCA
ExampleA_2009    GGTACGCCTTGCGTGGACAGTCCCTAGTTCTGATCAGTCT
ExampleB_2005    CGTACGCGTTGCGTGACAGTGCCTAGTTCTGATCAGTCA
;
END;
```

Bayesian Evolutionary Analysis by Sampling Trees

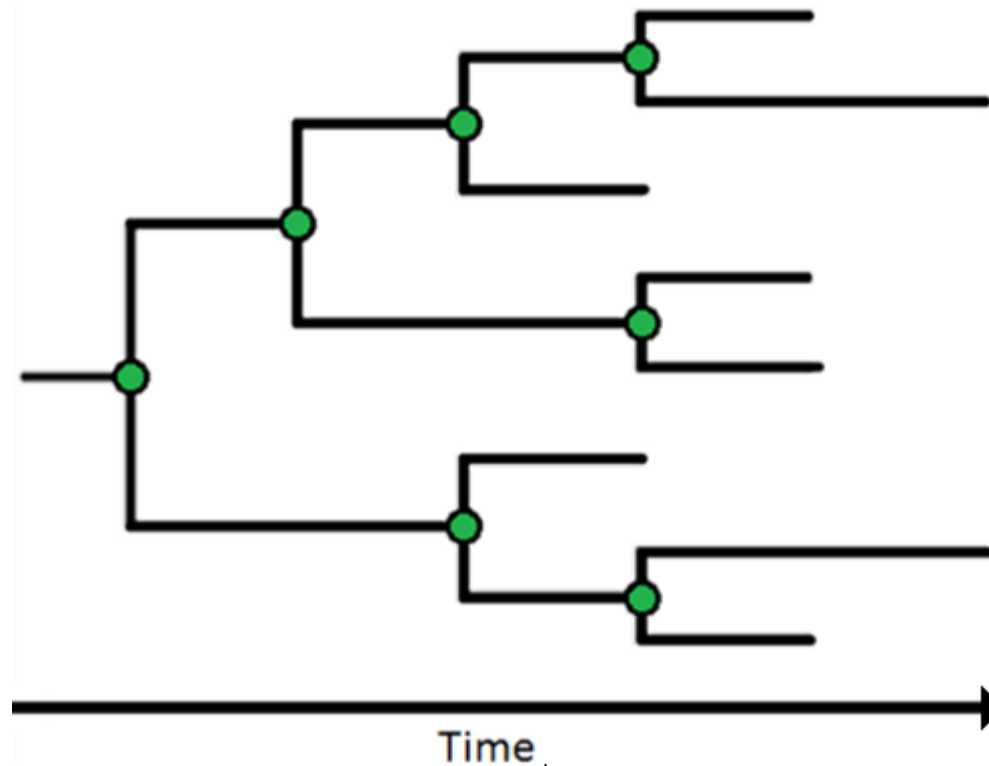

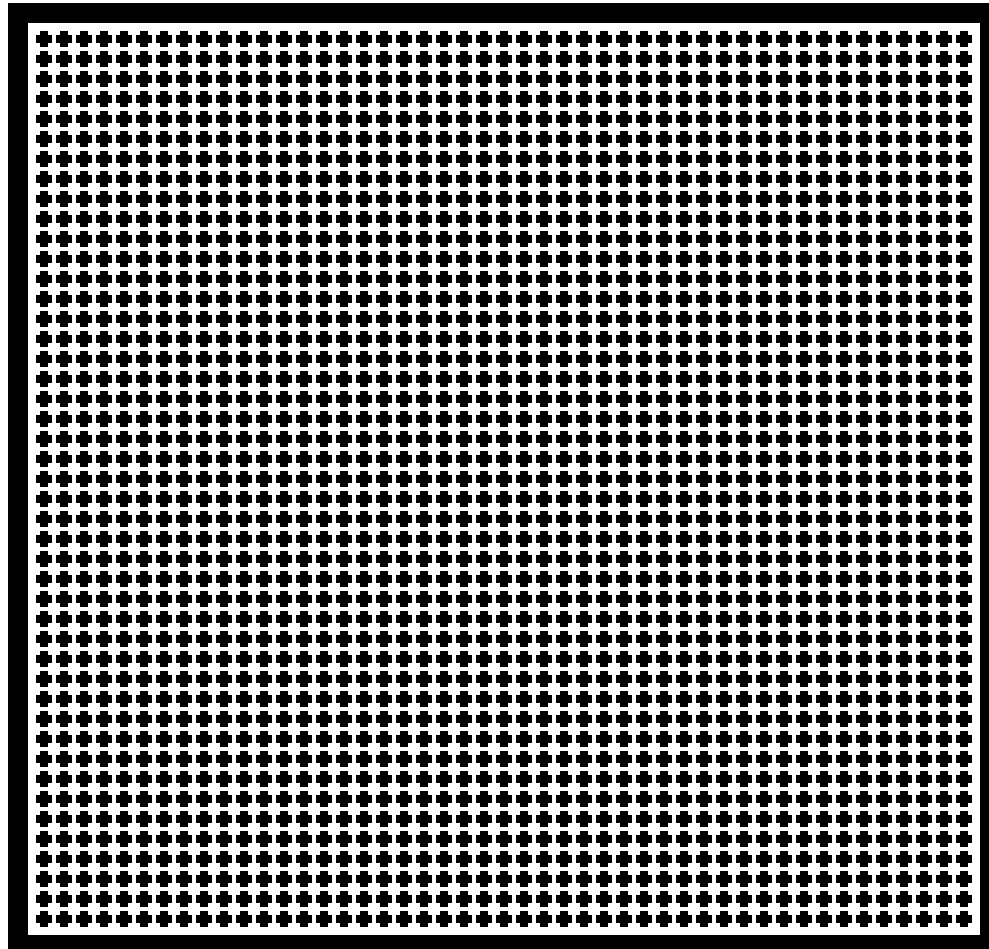

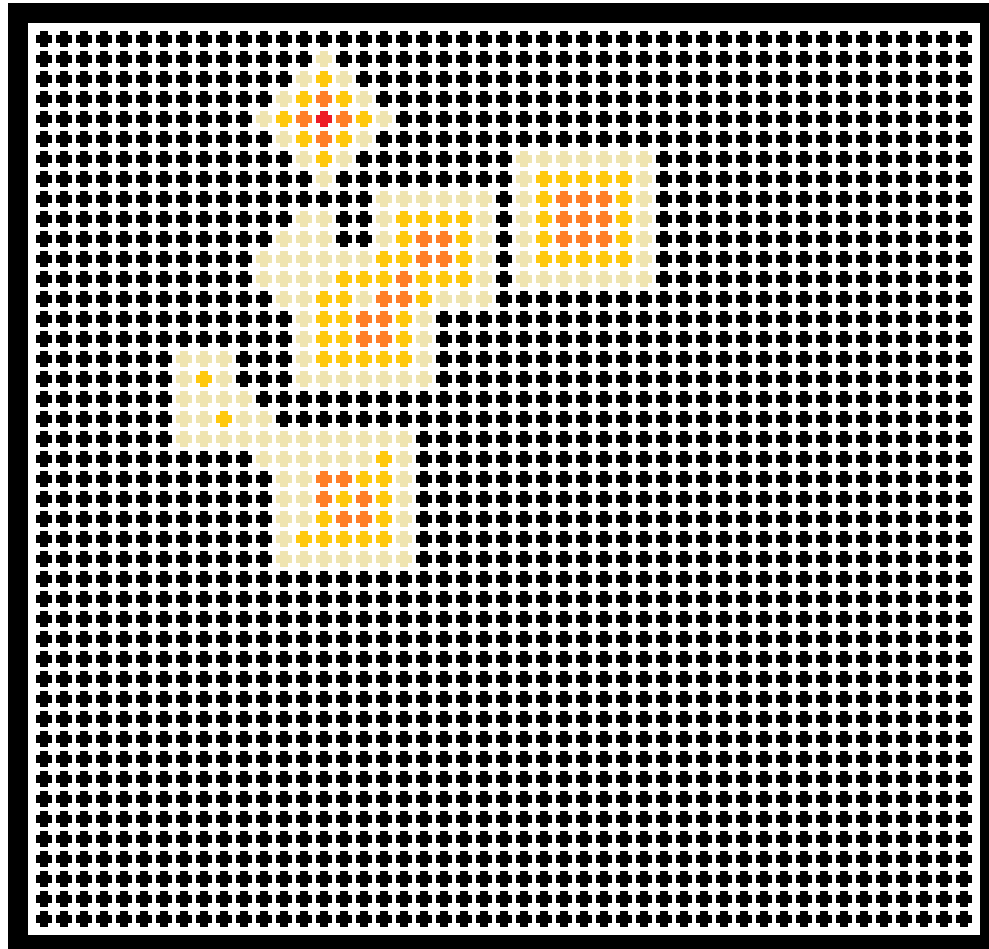

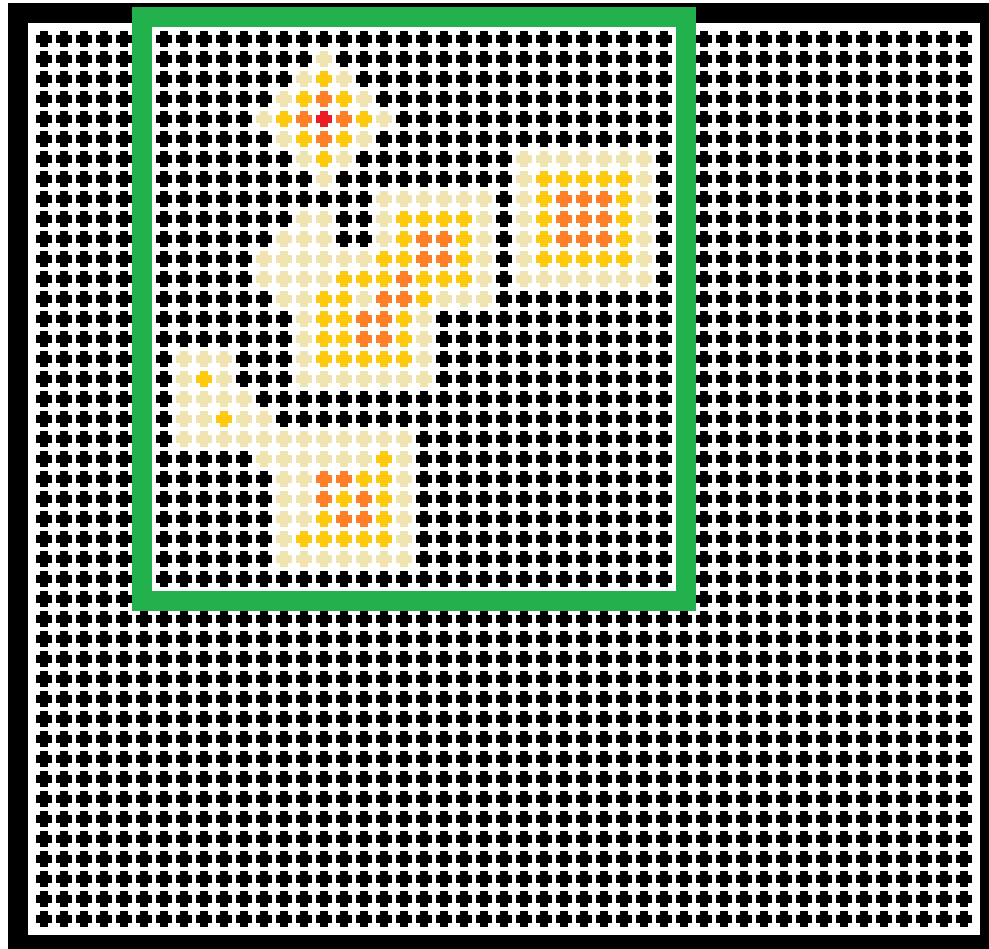

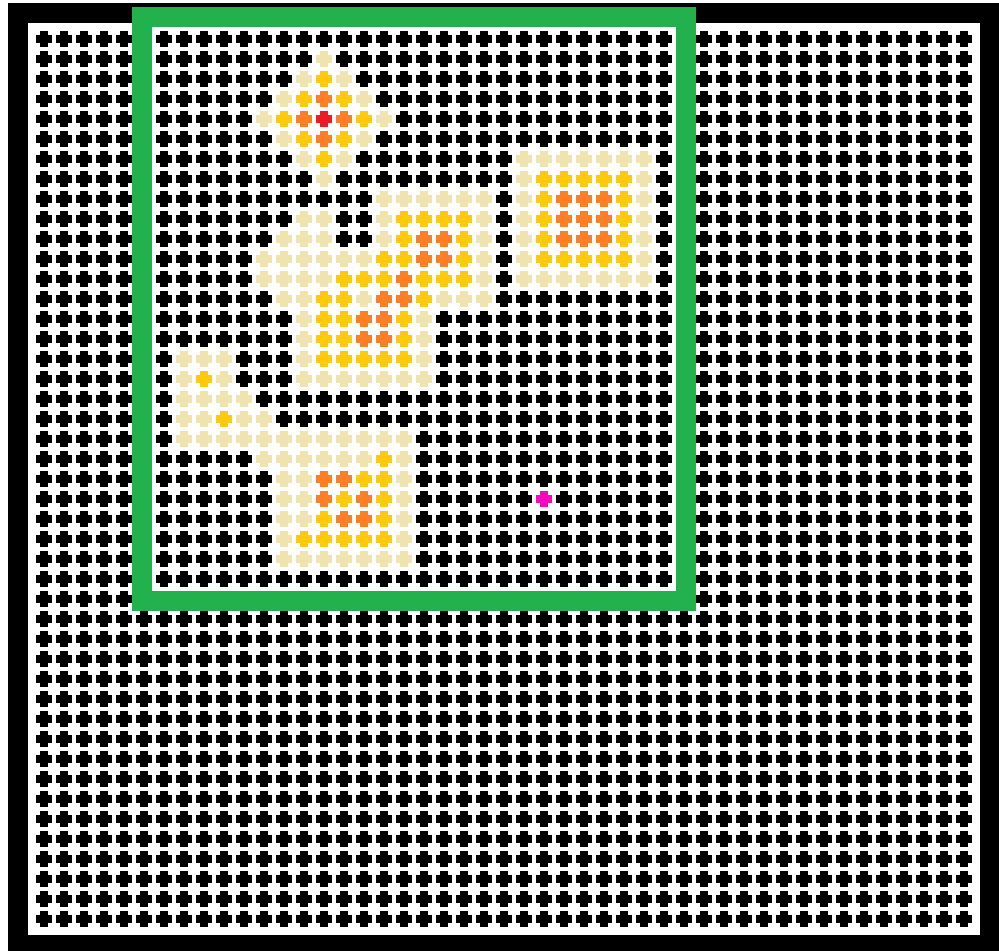

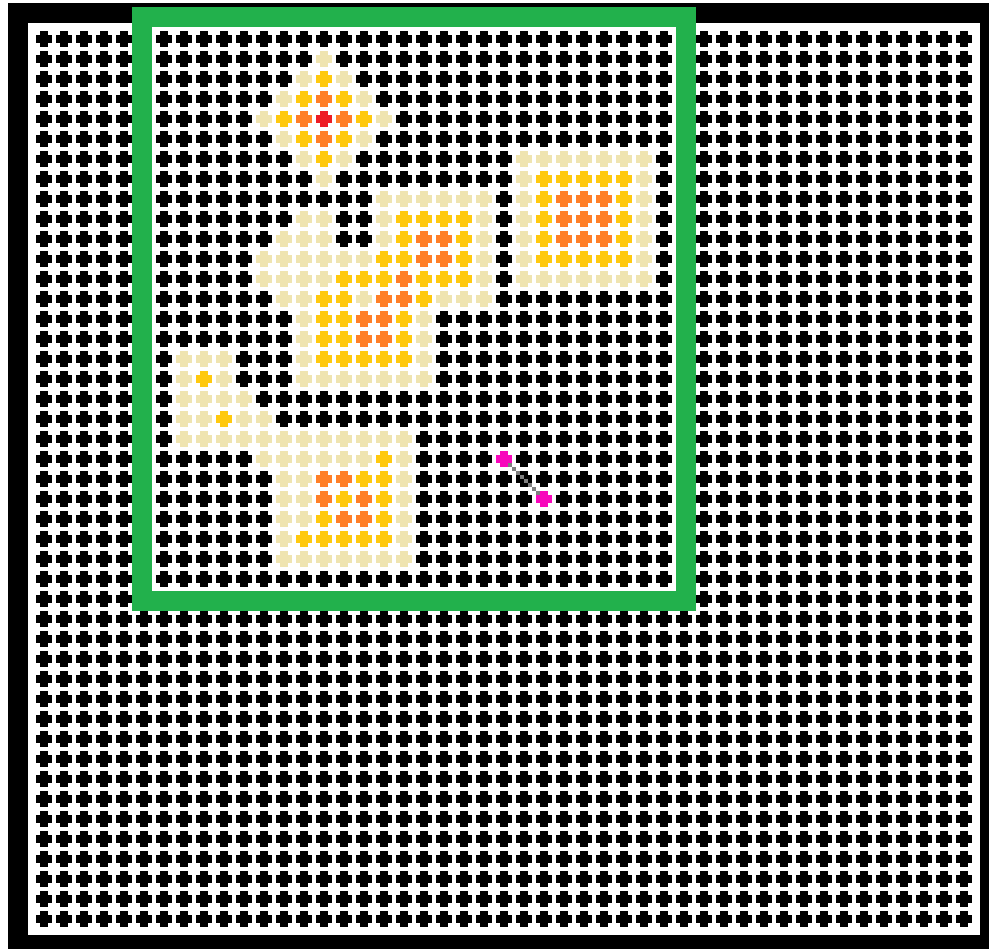

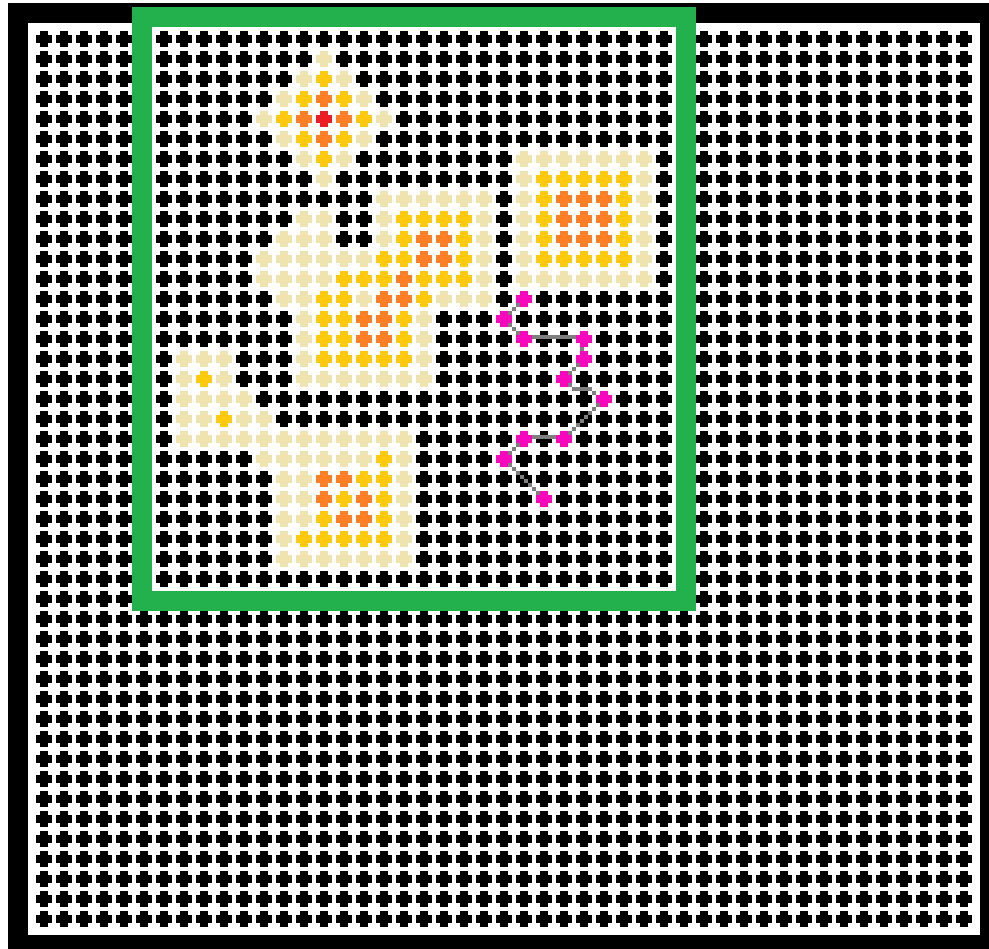

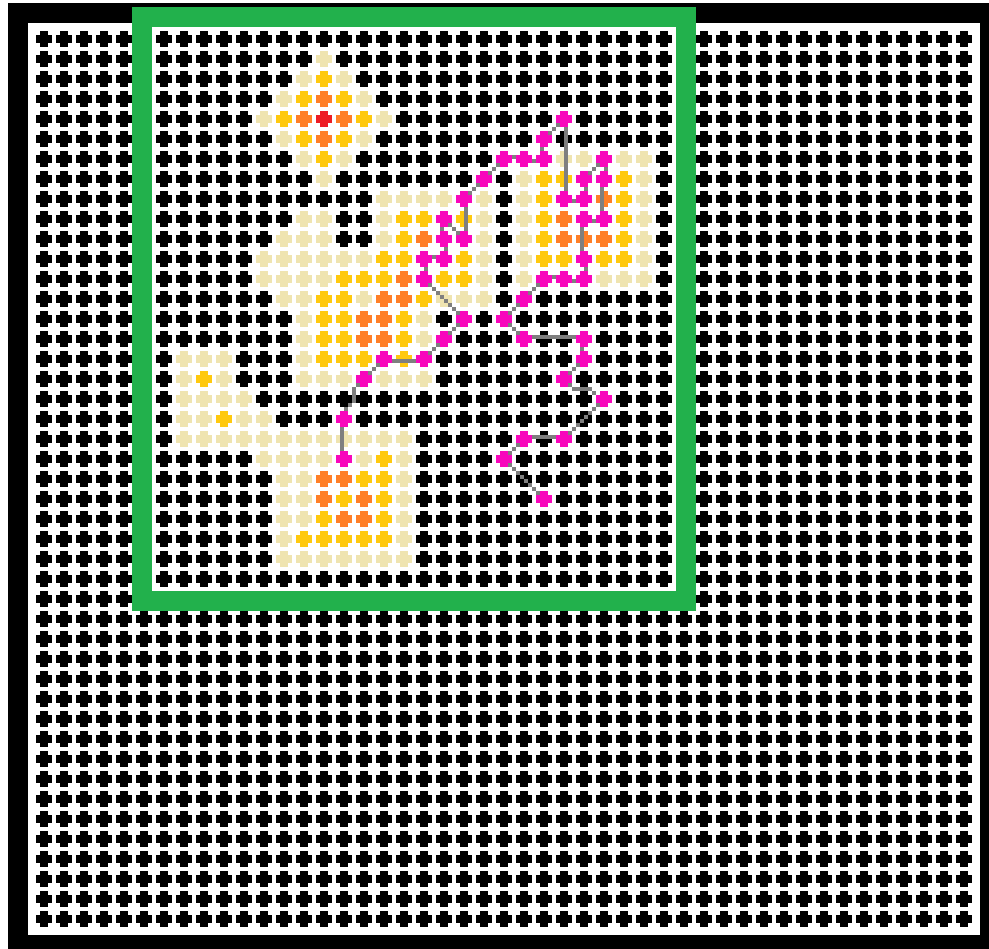

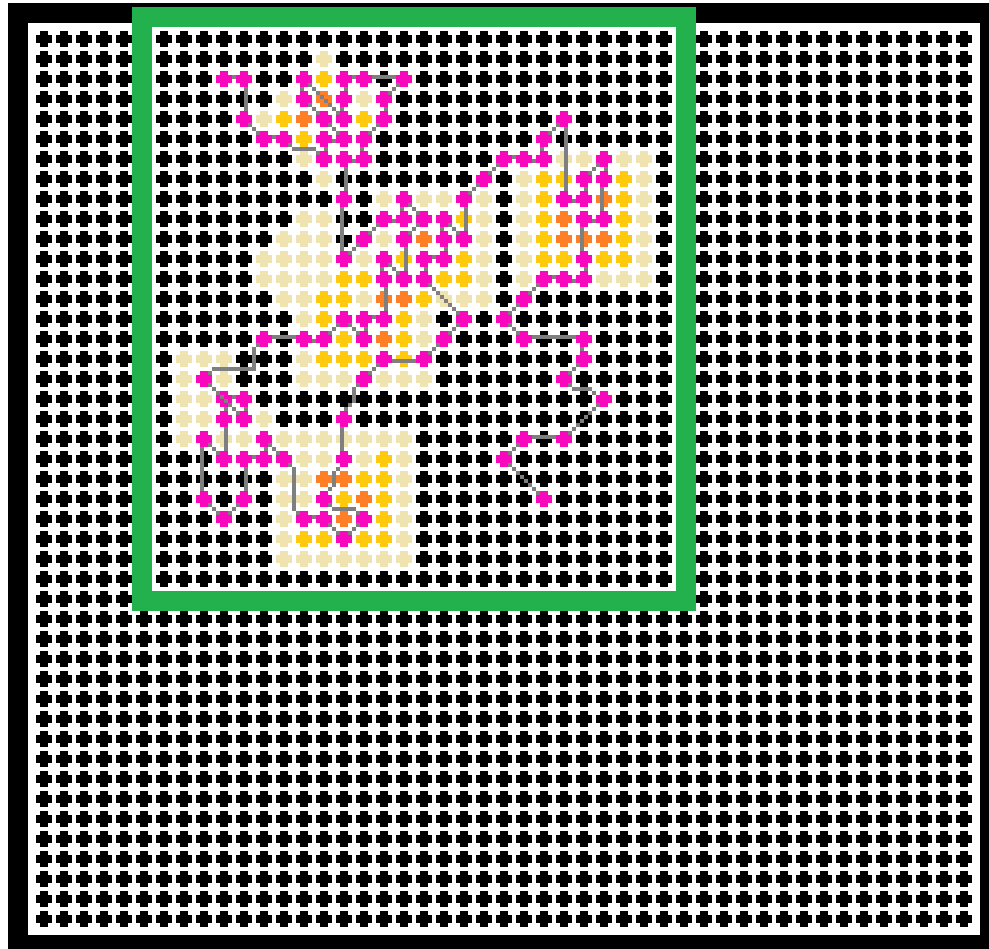

Bayesian Evolutionary Analysis Utility

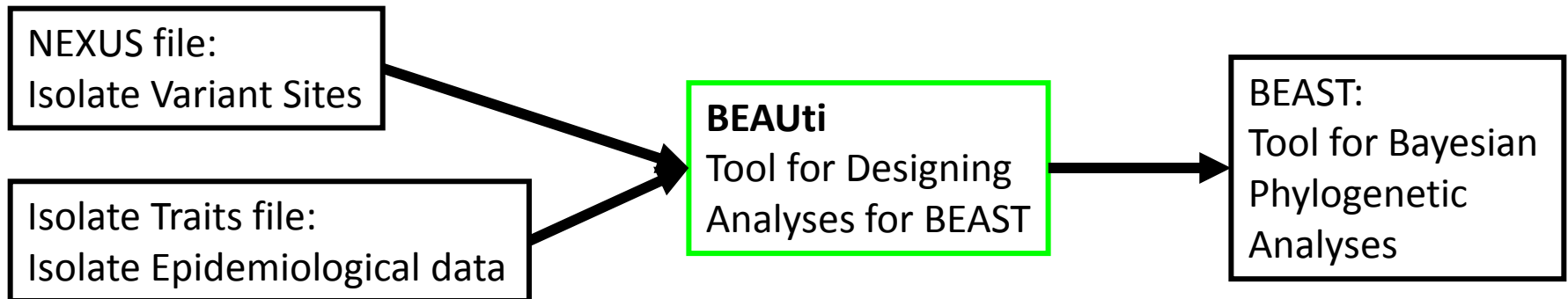



NEXUS File

```
# NEXUS

BEGIN DATA;
DIMENSIONS NTAX=3 NCHAR=40;
FORMAT MISSING=N GAP=- DATATYPE=DNA;
MATRIX;
IsolateId_Year           CGTACGCGTAGCGTGACAGTGCCTAGTTGTGATCTGTCA
ExampleA_2009            GGTACGCCTTGCGTGGACAGTCCCTAGTTCTGATCAGTCT
ExampleB_2005            CGTACGCGTTGCGTGACAGTGCCTAGTTCTGATCAGTCA
;
END;
```

Isolate Traits File

traits	Species	Location	Latitude	Longitude	CATTLE
ExampleA_2009	BOVINE	WHATAROA	-42.345	170.998	BOVINE
ExampleB_2005	POSSUM	WESTPORT	-41.543	171.321	NONBOVINE

BEAUti

File Edit Help

Import Data...

Import Alignment...

Look in: SequenceData

- sequences_11-08-15.fasta
- sequences_11-08-15.nexus

Recent Items



Desktop



My Documents



Computer



Network

File name: sequences_11-08-15.nexus

Files of type: NEXUS, BEAST or FASTA Files

Open

Cancel

+ - View Partition ... Create partition from trait ...

No data loaded - select 'Import Data...' from the 'File' menu.

Generate BEAST File...

Use tip dates
Guess Dates Set Dates Clear Dates Set Pre

Specify origin date:

Name
AgR136_1991
AgR145_1985
AgR146_1984
AgR150_1988
AgR155_1983
AgR191_1988
AgR197_1983
AgR200_1985
AgR202_1982
AgR206_1988
AgR210_1984
AgR213_1994
AgR222_1987
AgR225_1997
AgR227_2001
AgR229_2001
AgR232_2007
AgR233_2010
AgR234_2011
AgR235_1998
AgR236_1994
AgR237_2003
AgR238_2011
AgR239_2002

Tip date sampling: Off

Guess date values for all taxa

The date is given by a numerical field in the taxon label that is:

- Defined just by its order
- Defined by a prefix and its order
- Defined by regular expression (REGEX)
- Parse as a number
- Parse as a calendar date
- Parse calendar dates with variable precision

Order:

Prefix:

“ ” (REGEX)

Add the following value to each:

...unless less than:

...in which case add:

Date format: ?

Parse as a number

Parse as a number

Add the following value to each:

...unless less than:

...in which case add:

Date format: ?

Parse as a calendar date

Parse calendar dates with variable precision

last

“ ”

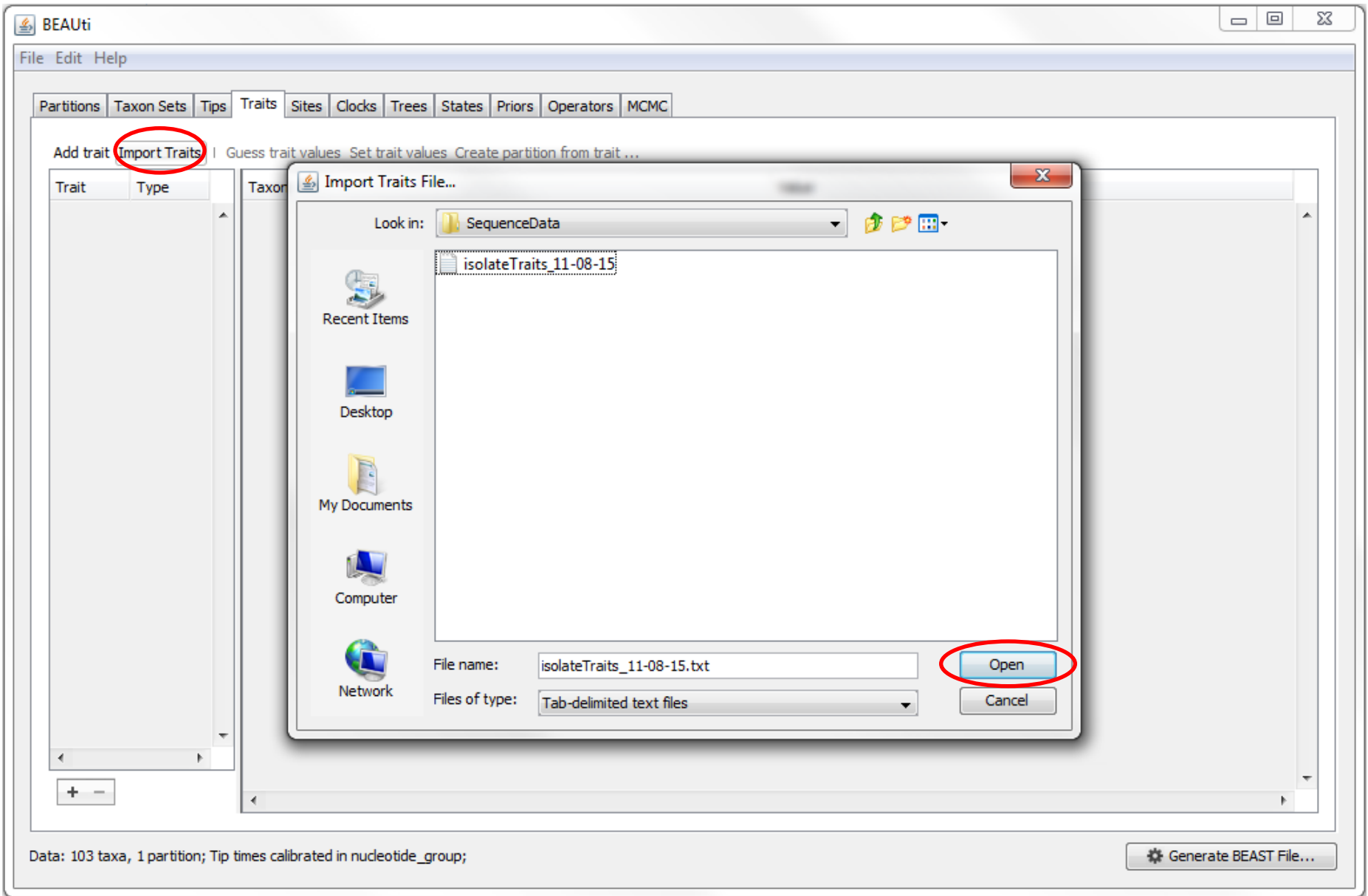

Add trait **Import Traits** | Guess trait values Set trait values **Create partition from trait ...**

Trait	Type
Species	discr...
Location	discr...
Area	discr...
REA	integer
Latitude	cont...
Longitude	cont...
CATTLE	discr...

Taxon	Value
-------	-------

- Substitution Model
- SubstitutionModel**
- CATTLE

Clone Settings...

Nucleotide Substitution Model - SubstitutionModel

Substitution Model: **HKY**

Base frequencies: **Estimated**

Site Heterogeneity Model: **None**

Number of Gamma Categories: **4**

Partition into codon positions: **Off**

- Link/Unlink parameters:
- Unlink substitution rate parameters across codon positions
 - Unlink rate heterogeneity model across codon positions
 - Unlink base frequencies across codon positions

Use Yang96 model

Use SRD06 model

ExampleA_2009 **G**GTACGC**C**TTGCGTG**G**ACAGT**C**CCTAGTTCTGATCAGT**C****T**
 ExampleB_2005 **C**GTACGC**G**TTGCGTG**C**ACAGT**G**CCTAGTTCTGATCAGT**C****A**

	A	C	G	T
A		?	?	?
C	?		?	?
G	?	?		?
T	?	?	?	

Jukes-Cantor	JC	1969	n=0
Hasegawa-Kishino-Yano	HKY	1985	n=4
Tamura-Nei	TN	1993	n=5
Generalised Time-Reversible	GTR	1986	n=8

Transitions

Transversions

- Substitution Model
- SubstitutionModel**
- CATTLE

Nucleotide Substitution Model - SubstitutionModel

Substitution Model: **HKY**

Base frequencies: **Estimated**

Site Heterogeneity Model: **Gamma**

Number of Gamma Categories: 4

Partition into codon positions: Off

Link/Unlink parameters:

- Unlink substitution rate parameters across codon positions
- Unlink rate heterogeneity model across codon positions
- Unlink base frequencies across codon positions

Use Yang96 model

Use SRD06 model

- Substitution Model
- SubstitutionModel
- CATTLE**

Discrete Traits Substitution Model - CATTLE

Discrete Trait Substitution Model: Symmetric substitution model

Infer social network with BSSVS

Clone Settings...

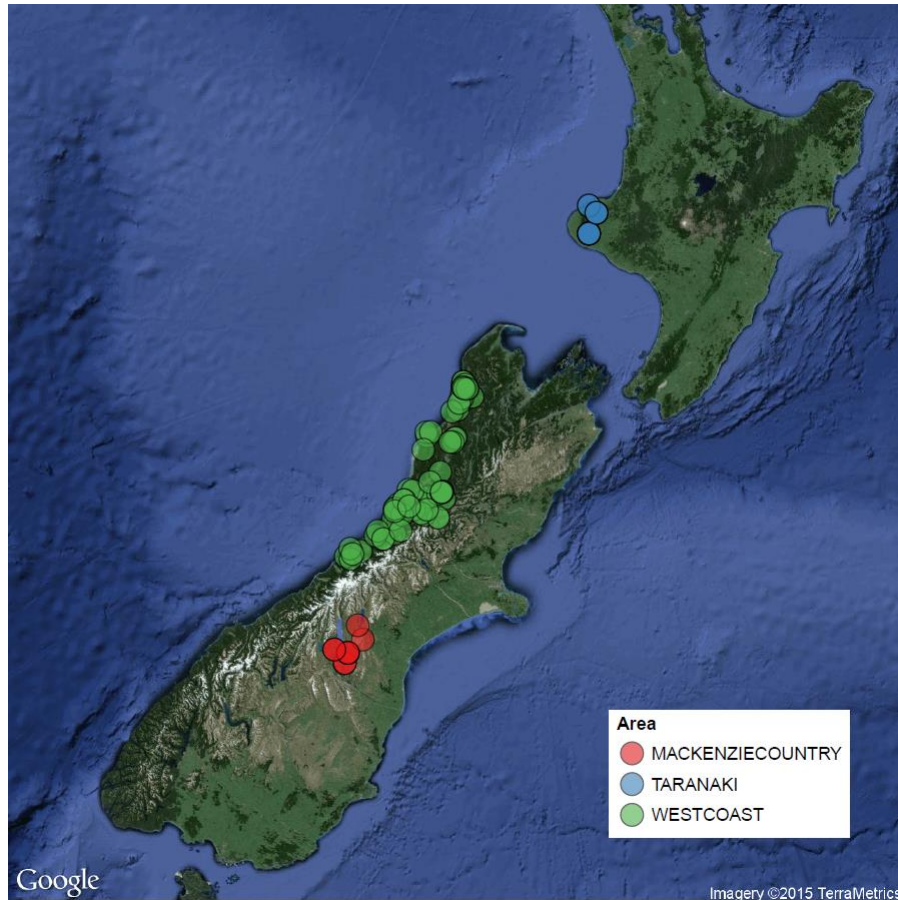

Sampling Range for each Species

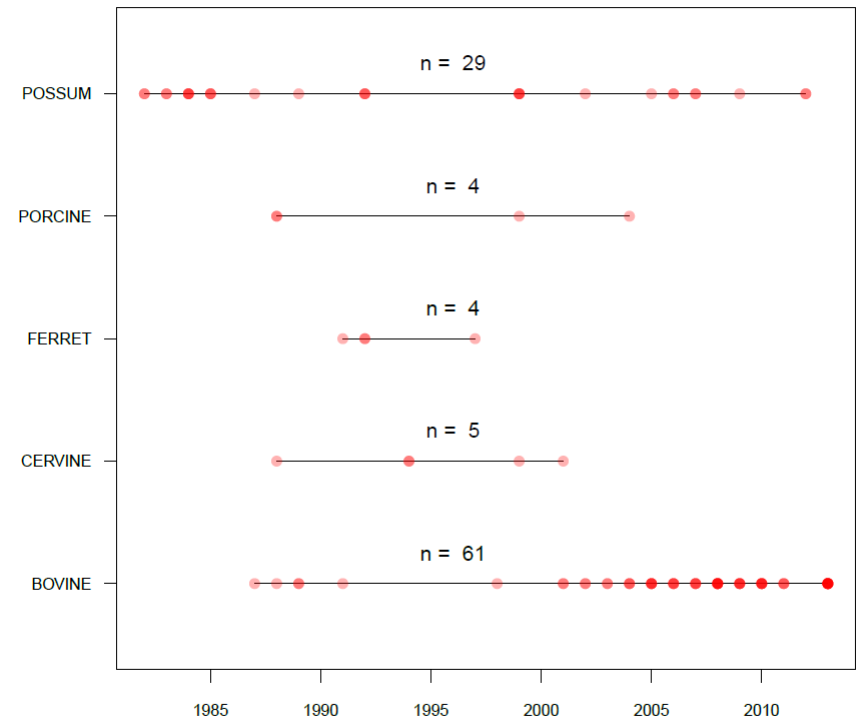

- Substitution Model
- SubstitutionModel
- CATTLE**

Discrete Traits Substitution Model - CATTLE

Discrete Trait Substitution Model: **Symmetric substitution model**

Infer social network with BSSVS

Asymmetric substitution model

Clone Settings...

Clock Model :

Name	Model	Estimate	Rate	Group
ClockModel	Strict clock	<input checked="" type="checkbox"/>	1.0	nucleotide group
CATTLE	Strict clock	<input checked="" type="checkbox"/>	1.0	generaldatatype group

Clock Model Group:

Group Name	Fix Mean	Rate
nucleotide_group	<input type="checkbox"/>	

+ -

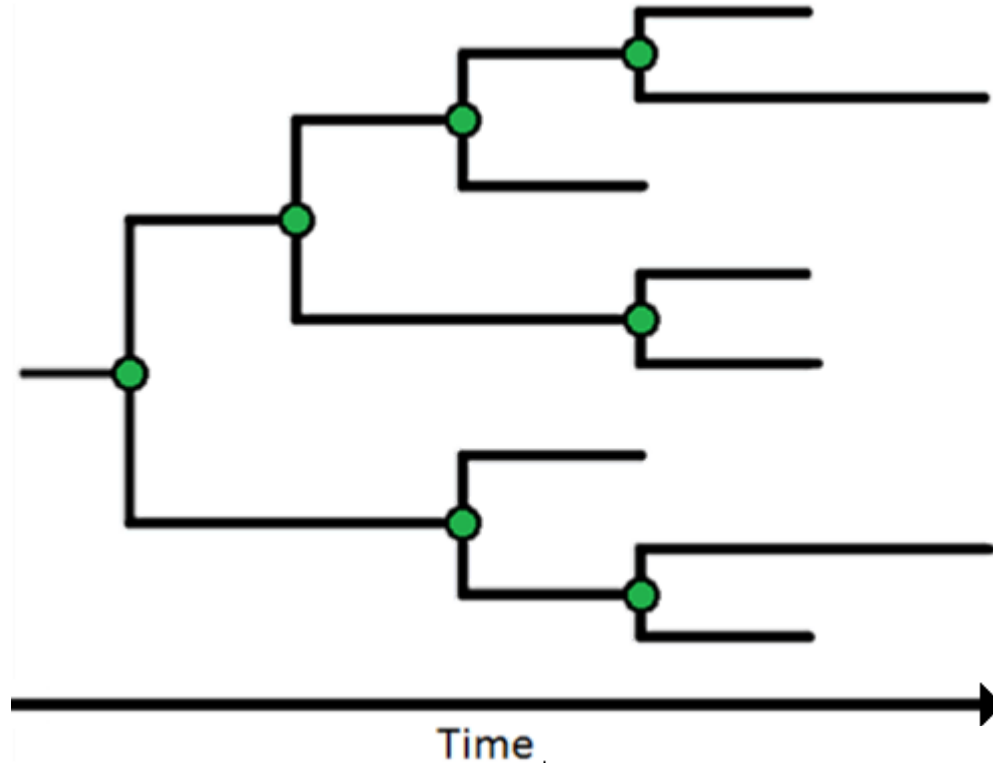

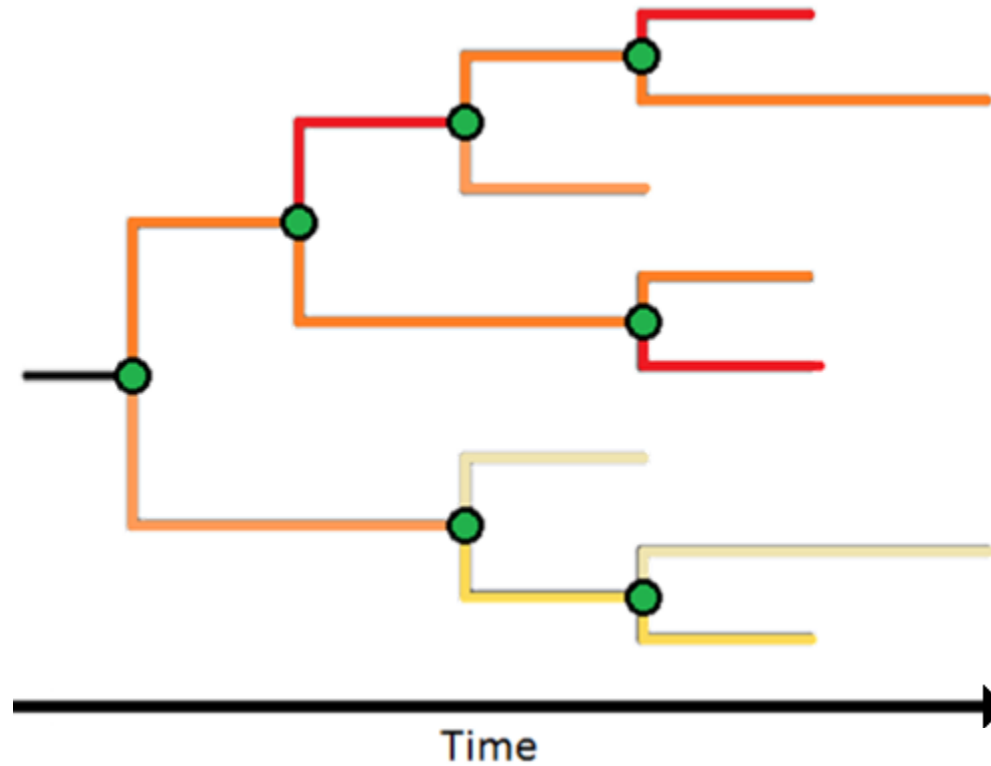

Clock Model :

Name	Model	Estimate	Rate	Group
ClockModel	Strict clock	<input checked="" type="checkbox"/>	1.0	nucleotide group
CATTLE	Strict clock	<input checked="" type="checkbox"/>	1.0	generaldatatype group

Exponential relaxed clock (Uncorrelated)

Clock Model Group:

Group Name	Fix Mean	Rate
nucleotide_group	<input type="checkbox"/>	

+ -

Link tree prior for all trees

- Trees
- TreeModel**

Tree prior shared by all tree models

Tree Prior: Coalescent: Constant Size

Citation: Kingman JFC (1982) Stoch Proc Appl 13, 235-248 [Constant Coalescent].
Drummond AJ, Nicholls GK, Rodrigo AG, Solomon W (2002) Genetics 161, 1307-1320 [Serially Sampled Data].

Tree Model - sequences_11-08-15

Random starting tree

UPGMA starting tree

User-specified starting tree

Select user-specified tree: no tree loaded

Export format for tree: Newick

Import user-specified starting trees from **NEXUS** format data files using the 'Import Data' menu option. Trees must be rooted and strictly bifurcating (binary).

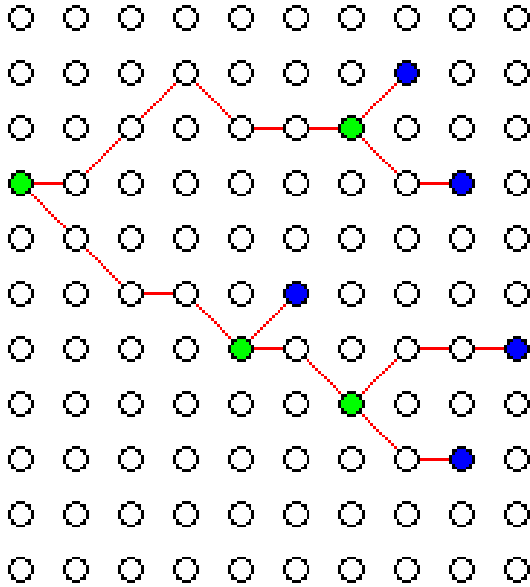

A phylogeny can be thought of as describing a random series of **coalescence events**.

The frequency and timings of **coalescence events** can be used to infer underlying population dynamics.

Coalescence events are likely to occur more frequently in smaller populations.

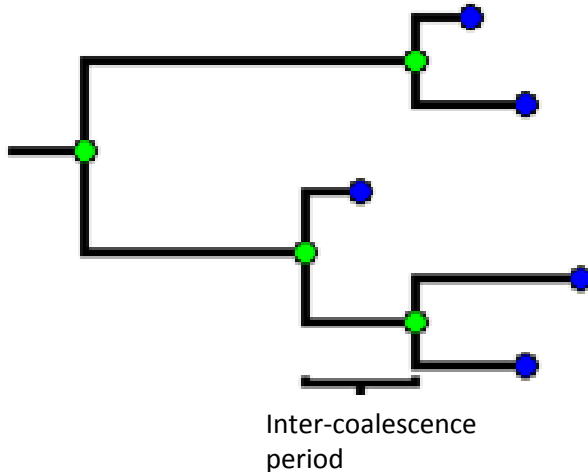

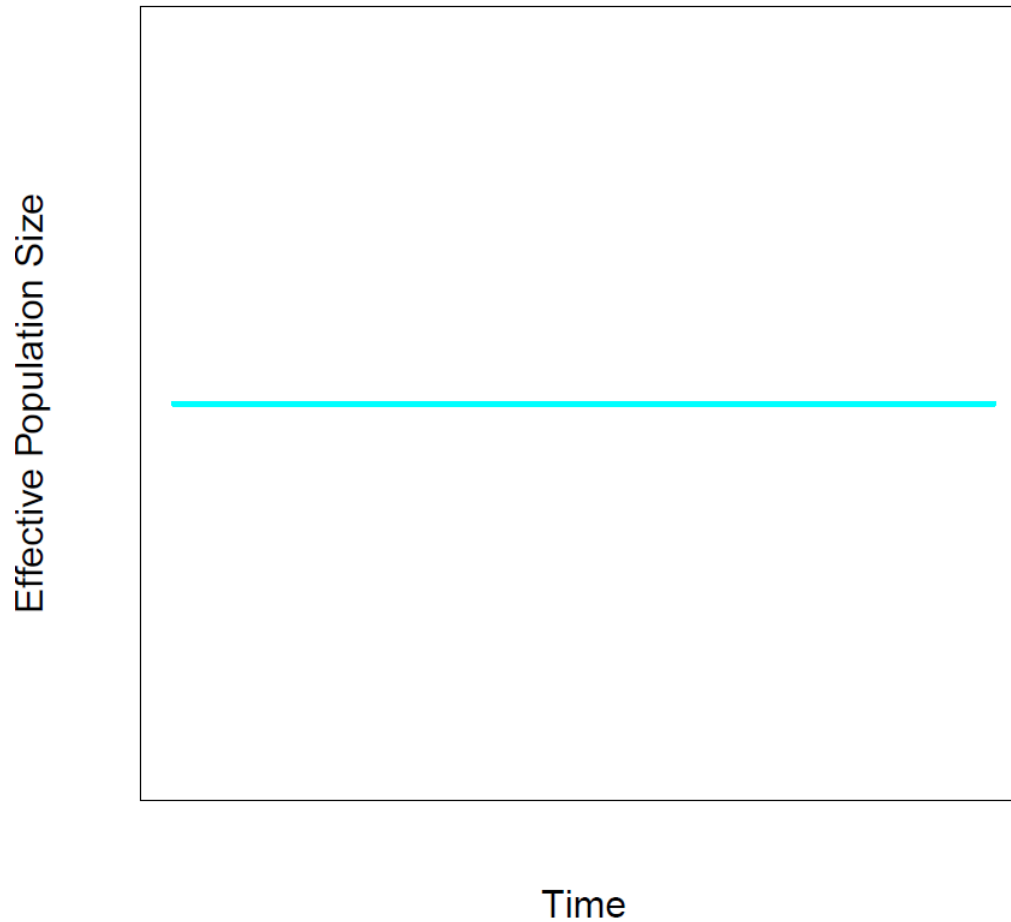

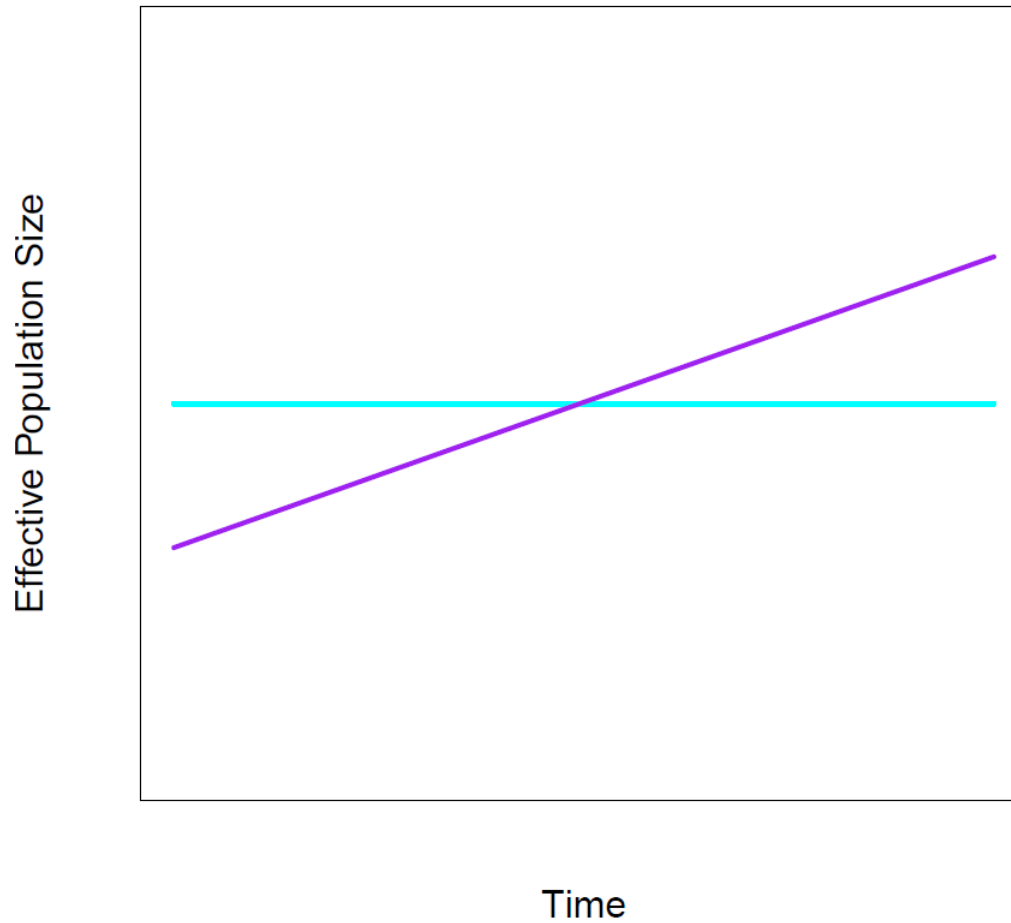

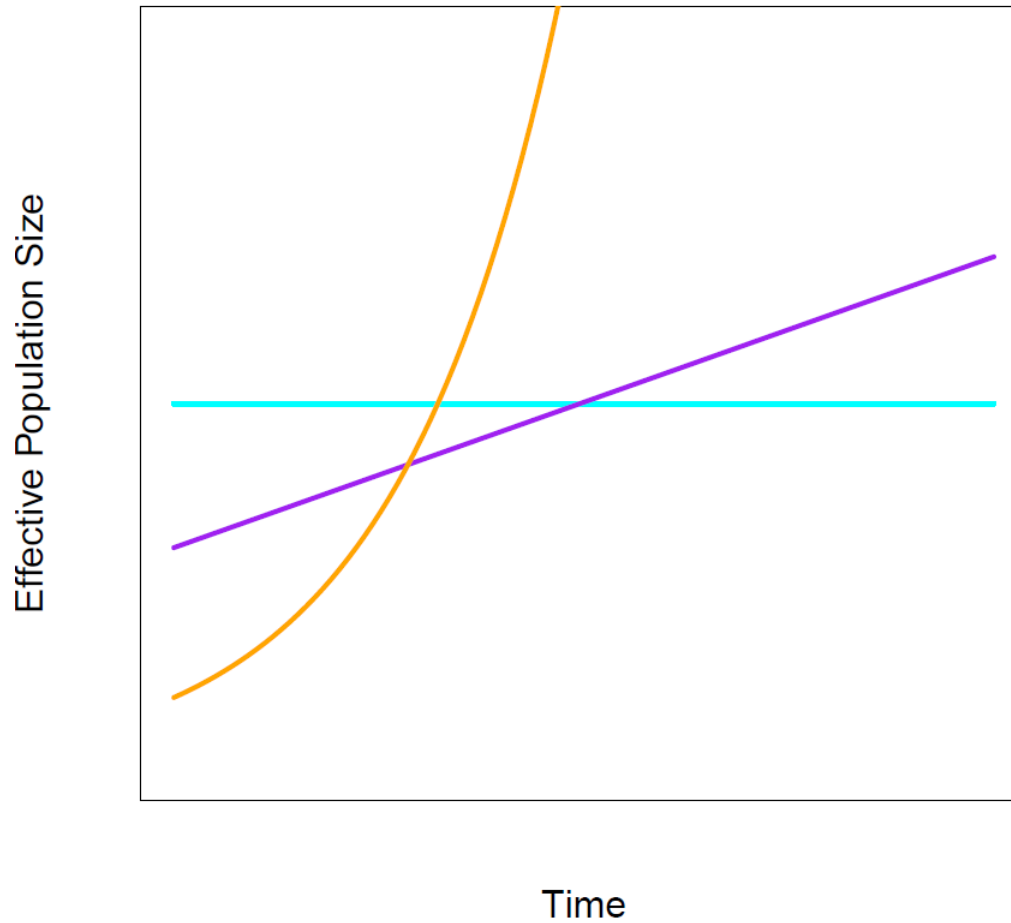

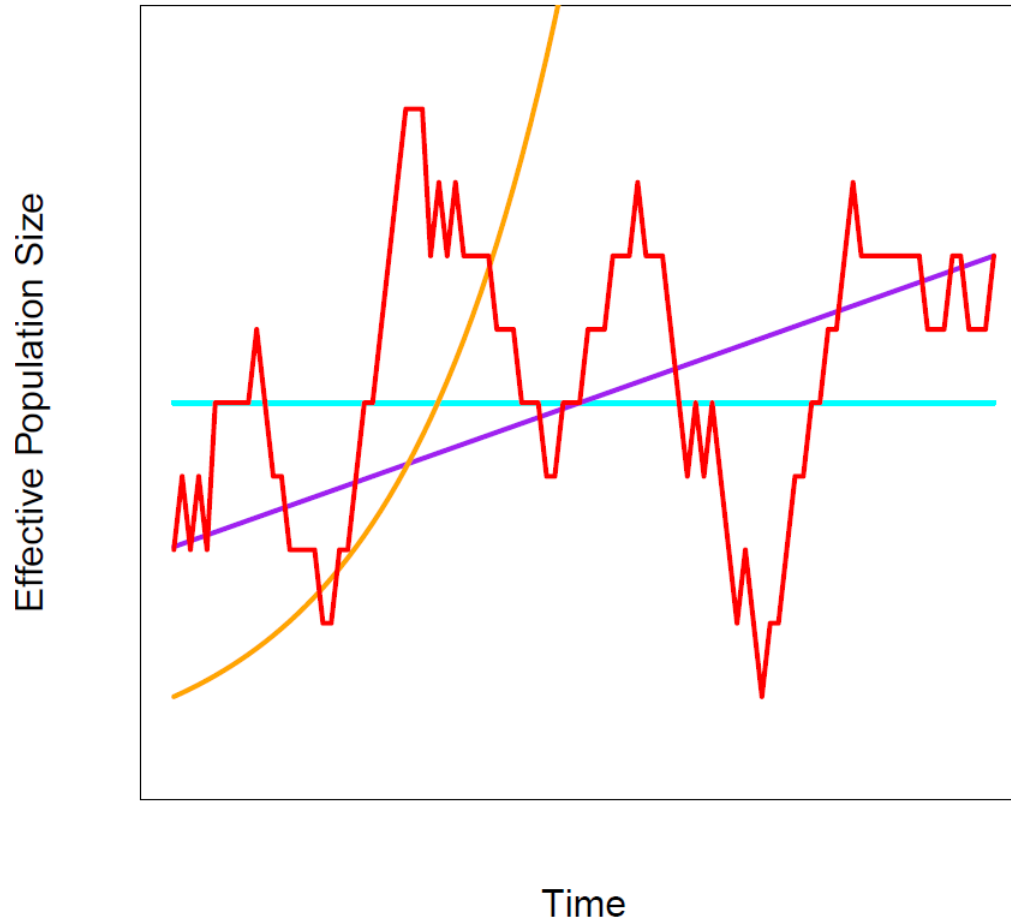

Link tree prior for all trees

- Trees
- TreeModel**

Tree prior shared by all tree models

Tree Prior: **Coalescent: Constant Size**

Citation: Kingman JFC (1982) Stoch Proc Appl 13, 285-248 [Constant Coalescent].
Drummond AJ, Nichol G, Quigg C, Heled J, Heled C, Loman NJ, et al. (2012) Selective Bayesian SkyGrid
Genetics 161, 130

Coalescent: GMRF Bayesian SkyGrid

Tree Model - sequences_11-08-15

Random starting tree

UPGMA starting tree

User-specified starting tree

Select user-specified tree: no tree loaded

Export format for tree: Newick

Import user-specified starting trees from **NEXUS** format data files using the 'Import Data' menu option. Trees must be rooted and strictly bifurcating (binary).

Priors for model parameters and statistics:

Parameter	Prior	Bound	Description
kappa	* LogNormal [1, 1.25], initial=2	[0, ∞]	HKY transition-transversion parameter
frequencies	* Uniform [0, 1], initial=0.25	[0, 1]	base frequencies
alpha	* Exponential [0.5], initial=0.5	[0, ∞]	gamma shape parameter
ClockModel.uced.mean	? Not yet specified	[0, ∞]	uncorrelated exponential relaxed clock mean
CATTLE.dock.rate	* Approx. Reference Prior, initial=1	[0, ∞]	substitution rate
treeModel.rootHeight	* Using Tree Prior in [306, ∞]	[306, ∞]	root height of the tree
skygrid.precision	* Gamma [0.001, 1000], initial=0.1	[0, ∞]	GMRF Bayesian SkyGrid precision
ClockModel.meanRate	* Indirectly Specified Through Other Parameter	n/a	The mean rate of evolution over the whole tree
ClockModel.covariance	* Indirectly Specified Through Other Parameter	n/a	The covariance in rates of evolution on each lineage with their ancestral lineages
ClockModel.coefficientOfVariation	* Indirectly Specified Through Other Parameter	n/a	The variation in rate of evolution over the whole tree
CATTLE.frequencies	* Uniform [0, 1], initial=0.25	[0, 1]	discrete state frequencies
CATTLE.rates	* Gamma [1, 1], initial=1	[0, ∞]	discrete trait instantaneous transition rates
CATTLE.root.frequencies	* Uniform [0, 1], initial=0.25	[0, 1]	discrete state root frequencies

Link parameters together | Link parameters into a hierarchical model | Unlink parameters

* Marked parameters currently have a default prior distribution. You should check that these are appropriate.

Data: 103 taxa, 2 partitions; Tip times calibrated in nucleotide_group; Estimate clock rate in generaldatatype_group;

Generate BEAST File...

Priors for model parameters and statistics:

Parameter	Prior	Bound	Description
kappa	* LogNormal [1, 1.25], initial=2	[0, ∞]	HKY transition-transversion parameter
frequencies	* Uniform [0, 1], initial=0.25	[0, 1]	base frequencies
alpha	* Exponential [0.5], initial=0.5	[0, ∞]	gamma shape parameter

Substitution Model

Link parameters together | Link parameters into a hierarchical model | Unlink parameters

* Marked parameters currently have a default prior distribution. You should check that these are appropriate.

Priors for model parameters and statistics:

Parameter	Prior	Bound	Description
ClockModel.uced.mean	? Not yet specified	[0, ∞]	uncorrelated exponential relaxed clock mean
treeModel.rootHeight	* Using Tree Prior in [306, ∞]	[306, ∞]	root height of the tree
ClockModel.meanRate	* Indirectly Specified Through Other Parameter	n/a	The mean rate of evolution over the whole tree
ClockModel.covariance	* Indirectly Specified Through Other Parameter	n/a	The covariance in rates of evolution on each lineage with their ancestral lineages
ClockModel.coefficientOfVariation	* Indirectly Specified Through Other Parameter	n/a	The variation in rate of evolution over the whole tree

Clock Model

Link parameters together | Link parameters into a hierarchical model | Unlink parameters

* Marked parameters currently have a default prior distribution. You should check that these are appropriate.

Priors for model parameters and statistics:

Parameter	Prior	Bound	Description
CATTLE.frequencies	* Uniform [0, 1], initial=0.25	[0, 1]	discrete state frequencies
CATTLE.rates	* Gamma [1, 1], initial=1	[0, ∞]	discrete trait instantaneous transition rates
CATTLE.root.frequencies	* Uniform [0, 1], initial=0.25	[0, 1]	discrete state root frequencies

Discrete Trait Analysis

Link parameters together Link parameters into a hierarchical model | Unlink parameters

* Marked parameters currently have a default prior distribution. You should check that these are appropriate.

Data: 103 taxa, 2 partitions; Tip times calibrated in nucleotide_group; Estimate clock rate in generaldatatype_group;

Generate BEAST File...

BEAUti

File Edit Help

Partitions Taxon Sets Tips Traits Sites Clocks Trees Stat

Priors for model parameters and statistics:

Parameter	Prior
kappa	* LogNormal [1, 1.25]
frequencies	* Uniform [0, 1], initial
alpha	* Exponential [0.5], initial
ClockModel.uced.mean	? Not yet specified
CATTLE.clock.rate	* Approx. Reference
treeModel.rootHeight	* Using Tree Prior in
skygrid.precision	* Gamma [0.001, 100]
ClockModel.meanRate	* Indirectly Specified
ClockModel.covariance	* Indirectly Specified
ClockModel.coefficientOfVariation	* Indirectly Specified
CATTLE.frequencies	* Uniform [0, 1], initial
CATTLE.rates	* Gamma [1, 1], initial
CATTLE.root.frequencies	* Uniform [0, 1], initial

Link parameters together Link parameters into a hierarchical model

* Marked parameters currently have a default prior distribution. You can change this in the Priors dialog.

Data: 103 taxa, 2 partitions; Tip times calibrated in nucleotide_group

Prior for Parameter ClockModel.uced.mean

Select prior distribution for ClockModel.uced.mean

Prior Distribution: Exponential

Initial value: 1.0

Mean: 1.0

Offset: 0.0

Truncate to:

Upper: +INF

Lower: 0.0

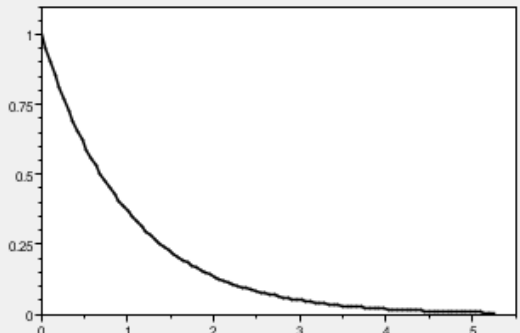

Quantiles: 2.5%: 2.532E-2
5%: 5.129E-2
Median: 0.693
95%: 2.996
97.5%: 3.689

OK Cancel

0.005

0.005

1

Generate BEAST File...

Length of chain: 10000000

500 000 000

50 000

Print to screen every: 1000

Log parameters every: 1000

50 000

File name stem: sequences_11-08-15

Add .txt suffix

NZ_1_28-08-15_HKY_Relaxed-Exponential_Skygrid_Cattle-Wildlife

Trees file name: sequences_11-08-15.trees

Create tree log file with branch length in substitutions:

Substitutions trees file name:

Create operator analysis file:

Operator analysis file name:



BEAST

Bayesian Evolutionary Analysis Sampling Trees
Version v1.8.2, 2002-2015

BEAST XML File:

Allow overwriting

Random number seed:

Thread pool size:

Use BEAGLE library if available:

Prefer use of:

Use CPU's

Prefer precision:

Rescaling scheme:

Show list of

BEAGLE is a high-performance phylogenetic analysis library that uses additional computational resources. It is available on SourceForge and can be downloaded and installed independently.

<http://beagle-lib.googlecode.com>

NZ_1_28-08-15_HKY_Relaxed-Exponential_Skygrid_Cattle-Wildlife.xml

File Edit Help

```
Branch rate model used: strictClockBranchRates
Using BEAGLE resource 0: CPU
  with instance flags: PRECISION_DOUBLE COMPUTATION_SYNCH EIGEN_COMPLEX SCALING_MANUAL SCALERS_RAW VECTOR_NONE THREADING_NONE PROCESSOR_CPU FRAMEWORK
Ignoring ambiguities in tree likelihood.
With 1 unique site patterns.
Using rescaling scheme : dynamic (rescaling every 100 evaluations)
Creating swap operator for parameter ClockModel.branchRates.categories (weight=10.0)
Optimization Schedule: log
```

Creating ctmcScalePrior model.

If you publish results using this prior, please reference:

1. Ferreira and Suchard (2008) for the conditional reference prior on CTMC scale parameter prior;

Constructing a cache around likelihood 'null', signal = CATTLE.rates

Likelihood computation is using an auto sizing thread pool.

Creating the MCMC chain:

```
chainLength=500000000
autoOptimize=true
autoOptimize delayed for 5000000 steps
```

BEAST v1.8.2, r6687

Generated Tue Sep 01 09:03:43 BST 2015 [seed=1441048672824]

state	Posterior	Prior	Likelihood	rootHeight	ClockModel.uced.mean	CATTLE.clock.rate
0	-55636.7037	-2779.8602	-52856.8435	392.682	5E-3	1.00000
50000	-14778.5369	-850.3737	-13928.1632	138.025	3.67378E-4	2.3569E-3
100000	-14133.7440	-829.6907	-13304.0533	143.620	2.35725E-4	2.95104E-3

Trace Files:

Trace File	States	Burn-In
NZ_1_28-08-15_HK...	500000000	500000000

+ -

Traces:

Statistic	Mean	ESS	...
posterior	-14019.921	1323	R
prior	-761.792	1238	R
likelihood	-13258.129	8723	R
treeModel.rootHeight	90.982	800	R
skygrid.precision	1.164	6846	R
skygrid.logPopSize1	4.574	6441	R
skygrid.logPopSize2	6.466	6242	R
skygrid.logPopSize3	6.169	3267	R
skygrid.logPopSize4	6.252	2740	R
skygrid.logPopSize5	6.056	2743	R
skygrid.logPopSize6	5.906	1398	R
skygrid.logPopSize7	5.154	896	R
skygrid.logPopSize8	4.646	1444	R
skygrid.logPopSize9	4.665	2494	R
skygrid.logPopSize10	4.664	1638	R
skygrid.logPopSize11	4.383	1268	R
skygrid.logPopSize12	3.905	1130	R
skygrid.logPopSize13	3.357	1196	R
skygrid.logPopSize14	2.91	1464	R
skygrid.logPopSize15	2.583	2555	R
skygrid.logPopSize16	2.356	3816	R
skygrid.logPopSize17	2.211	5988	R
skygrid.logPopSize18	2.131	7236	R
skygrid.logPopSize19	2.104	7904	R
skygrid.logPopSize20	2.065	8279	R
skygrid.logPopSize21	2.046	8484	R
skygrid.logPopSize22	2.027	8157	R
skygrid.logPopSize23	2.005	8206	R
skygrid.logPopSize24	1.99	8413	R
skygrid.logPopSize25	1.985	8704	R
skygrid.logPopSize26	1.988	8898	R
skygrid.logPopSize27	1.994	9001	R
skygrid.logPopSize28	1.97	8922	R
skygrid.logPopSize29	1.993	8963	R
skygrid.logPopSize30	1.975	9001	R
skygrid.logPopSize31	1.973	9001	R
skygrid.logPopSize32	1.961	9001	R
skygrid.logPopSize33	1.947	9001	R
skygrid.logPopSize34	1.949	9001	R
skygrid.logPopSize35	1.933	9001	R
skygrid.logPopSize36	1.921	9001	R
skygrid.logPopSize37	1.933	9001	R
skygrid.logPopSize38	1.909	9001	R
skygrid.logPopSize39	1.908	9001	R

Data type: (R)real (I)nt (C)at

Summary Statistic

mean	-14019.9215
stderr of mean	0.6232
stdev	22.668
variance	513.8369
median	-14019.6049
mode	n/a
geometric mean	n/a
95% HPD Interval	[-14062.8079, -13975.585]
auto-correlation time (ACT)	3.4022E5
effective sample size (ESS)	1322.8357

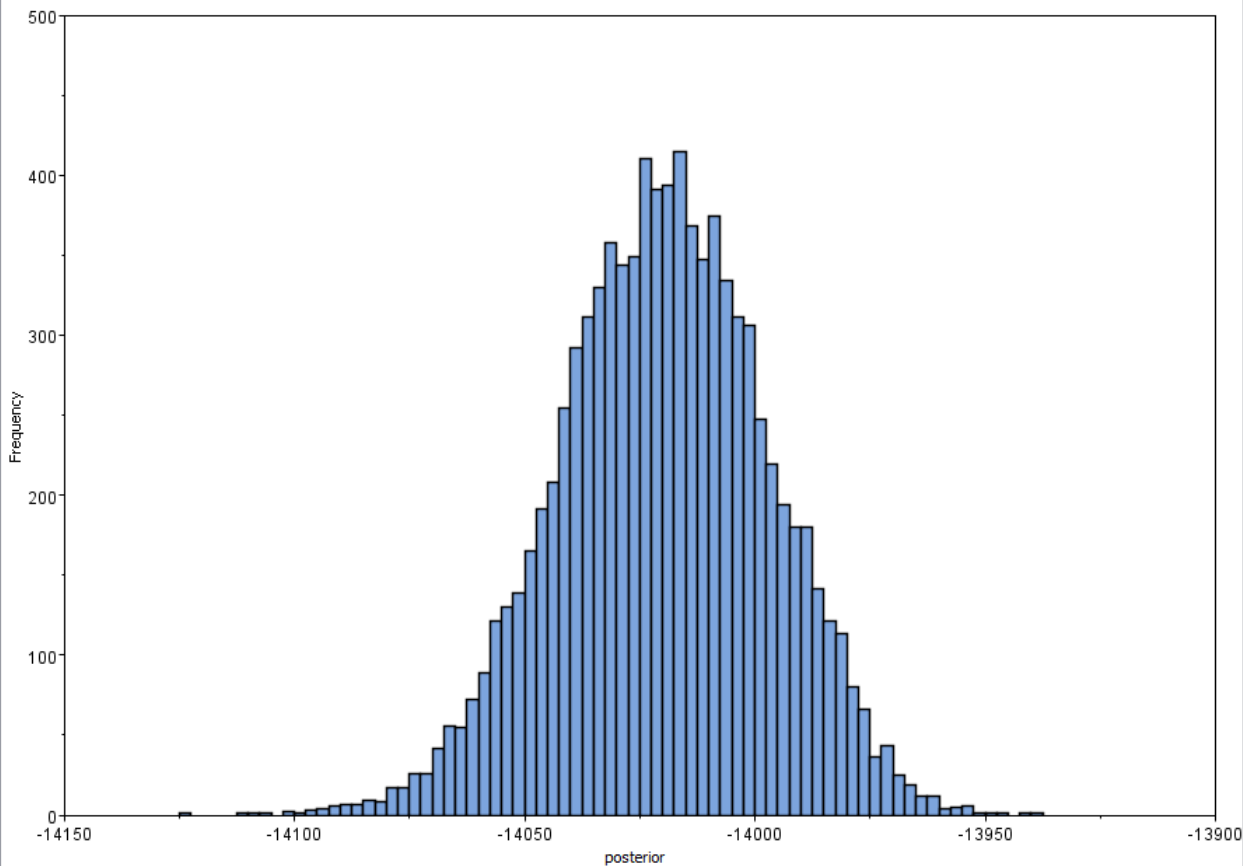

Axes... Bins: 50

Trace Files:

Trace File	States	Burn-In
NZ_1_28-08-15_HK...	500000000	500000000

Traces:

Statistic	Mean	ESS	...
posterior	-14019.921	1323	R
prior	-761.792	1238	R
likelihood	-13258.129	8723	R
treeModel.rootHeight	90.982	800	R
skygrid.precision	1.164	6846	R
skygrid.logPopSize1	4.574	6441	R
skygrid.logPopSize2	6.466	6242	R
skygrid.logPopSize3	6.169	3267	R
skygrid.logPopSize4	6.252	2740	R
skygrid.logPopSize5	6.056	2743	R
skygrid.logPopSize6	5.906	1398	R
skygrid.logPopSize7	5.154	896	R
skygrid.logPopSize8	4.646	1444	R
skygrid.logPopSize9	4.665	2494	R
skygrid.logPopSize10	4.664	1638	R
skygrid.logPopSize11	4.383	1268	R
skygrid.logPopSize12	3.905	1130	R
skygrid.logPopSize13	3.357	1196	R
skygrid.logPopSize14	2.91	1464	R
skygrid.logPopSize15	2.583	2555	R
skygrid.logPopSize16	2.356	3816	R
skygrid.logPopSize17	2.211	5988	R
skygrid.logPopSize18	2.131	7236	R
skygrid.logPopSize19	2.104	7904	R
skygrid.logPopSize20	2.065	8279	R
skygrid.logPopSize21	2.046	8484	R
skygrid.logPopSize22	2.027	8157	R
skygrid.logPopSize23	2.005	8206	R
skygrid.logPopSize24	1.99	8413	R
skygrid.logPopSize25	1.985	8704	R
skygrid.logPopSize26	1.988	8898	R
skygrid.logPopSize27	1.994	9001	R
skygrid.logPopSize28	1.97	8922	R
skygrid.logPopSize29	1.993	8963	R
skygrid.logPopSize30	1.975	9001	R
skygrid.logPopSize31	1.973	9001	R
skygrid.logPopSize32	1.961	9001	R
skygrid.logPopSize33	1.947	9001	R
skygrid.logPopSize34	1.949	9001	R
skygrid.logPopSize35	1.933	9001	R
skygrid.logPopSize36	1.921	9001	R
skygrid.logPopSize37	1.933	9001	R
skygrid.logPopSize38	1.909	9001	R
skygrid.logPopSize39	1.908	9001	R

Data type: (R)real (I)nt (C)at

Estimates Marginal Prob Distribution Joint-Marginal Trace

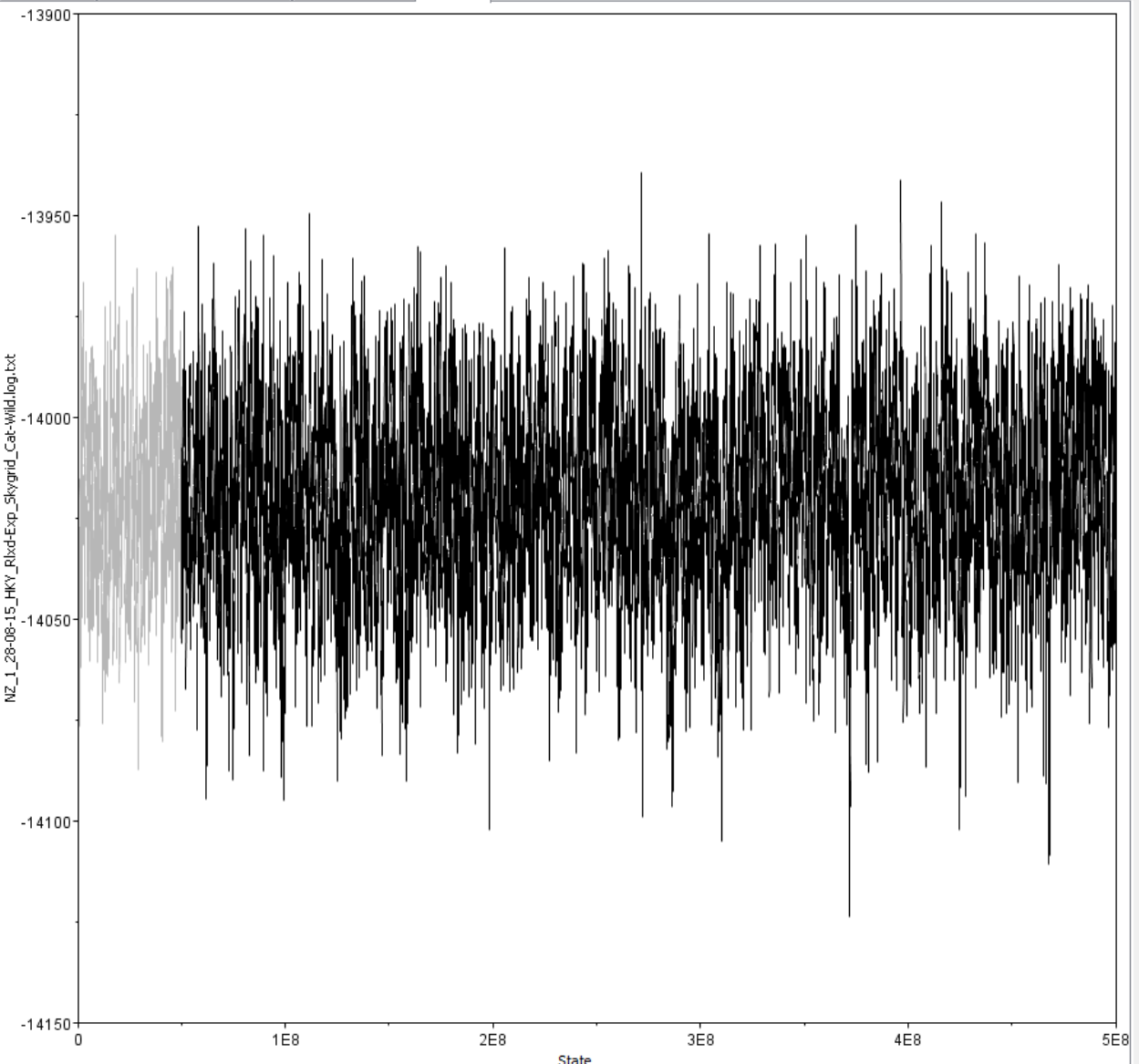

Axis... Show Burn-in Sample only Draw line plot Legend: None Colour by: Trace Listen

Trace Files:

Trace File	States	Burn-In
NZ_1_13-08-15_GT...	46900000	46900000

Traces:

Statistic	Mean	ESS	...
posterior	-16267.392	68	R
prior	-3087.49	50	R
likelihood	-13179.902	232	R
treeModel.rootHeight	224.027	83	R
skyline.popSize1	59.582	385	R
skyline.popSize2	144.068	162	R
skyline.popSize3	364.45	170	R
skyline.popSize4	602.427	197	R
skyline.popSize5	683.913	201	R
skyline.popSize6	661.806	166	R
skyline.popSize7	578.859	230	R
skyline.popSize8	381.102	216	R
skyline.popSize9	253.149	115	R
skyline.popSize10	109.631	92	R
skyline.groupSize1	6.231	224	R
skyline.groupSize2	4.844	292	R
skyline.groupSize3	8.599	137	R
skyline.groupSize4	13.005	201	R
skyline.groupSize5	12.908	209	R
skyline.groupSize6	12.842	200	R
skyline.groupSize7	12.304	250	R
skyline.groupSize8	11.608	218	R
skyline.groupSize9	11.241	202	R
skyline.groupSize10	8.417	87	R
kappa	5.499	361	R
frequencies1	0.193	424	R
frequencies2	0.309	424	R
frequencies3	0.311	424	R
frequencies4	0.188	265	R
alpha	13.996	424	R
uced.mean	3.218E-4	64	R
meanRate	2.51E-4	51	R
coefficientOfVariation	0.923	257	R
covariance	-1.79E-5	327	R
LatLongs.precision.col11	0.208	347	R
LatLongs.precision.col12	-0.147	351	R
LatLongs.precision.col21	-0.147	351	R
LatLongs.precision.col22	0.203	378	R
correlation	0.712	337	R
LatLongs.varCovar.LatLon...	10.27	356	R
LatLongs.varCovar.LatLon...	7.434	370	R
LatLongs.varCovar.LatLon...	7.434	370	R
LatLongs.varCovar.LatLon...	10.54	417	R
LatLongs.diffusionRate	1.53	47	R

Data type: (R)real (I)nt (C)at

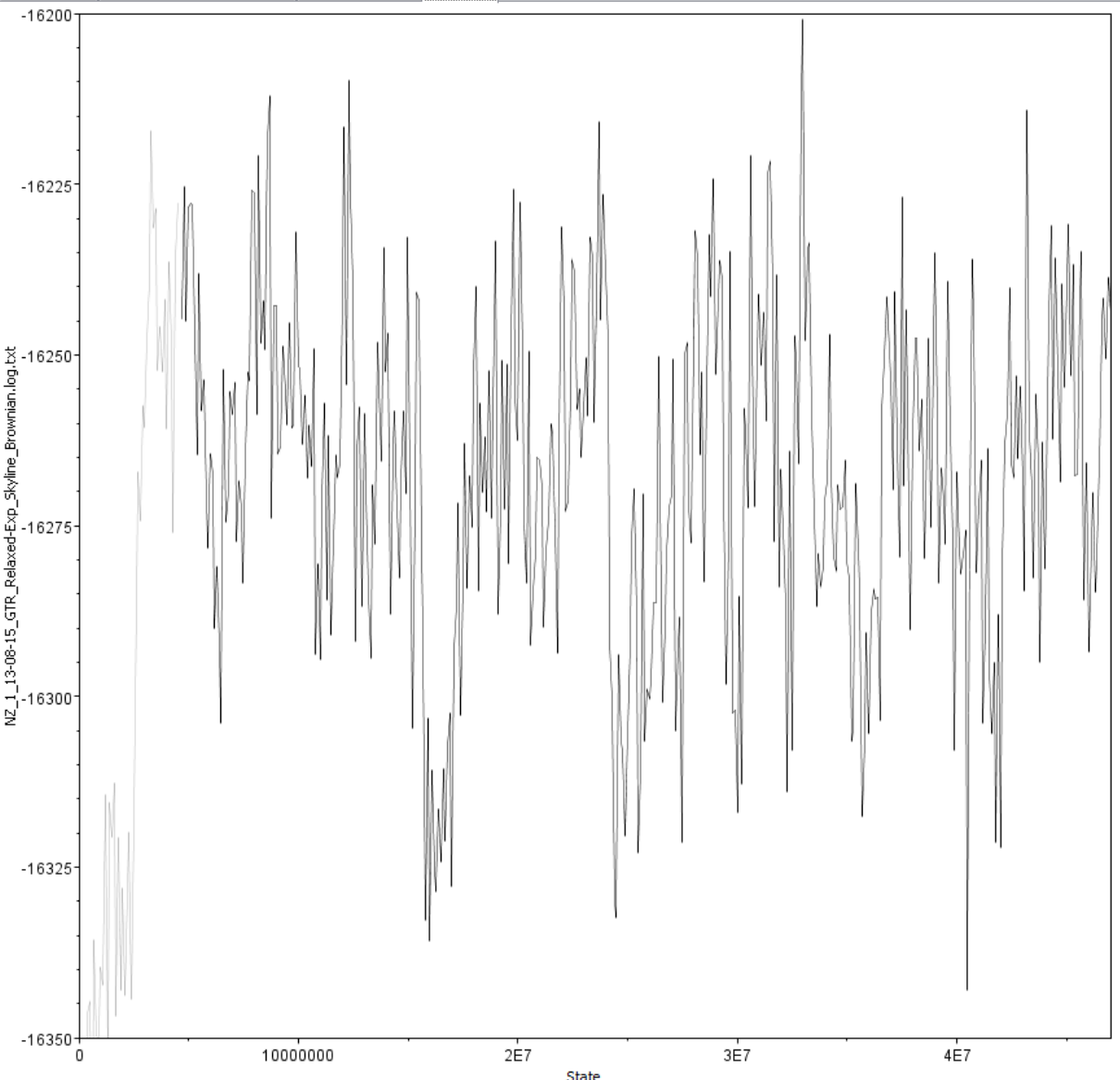

Mean Clock Rate Posterior Distribution

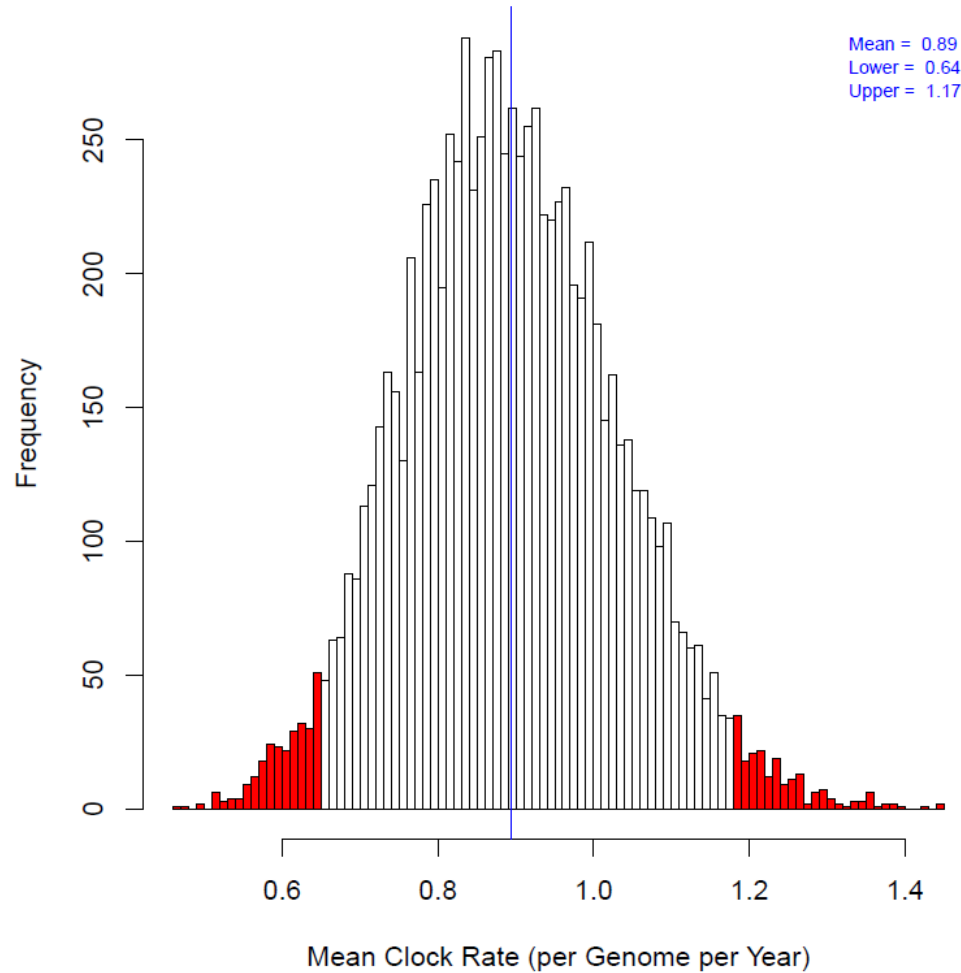

M.bovis Transition Rate Posterior Distributions Cattle \leftrightarrow Non-Cattle

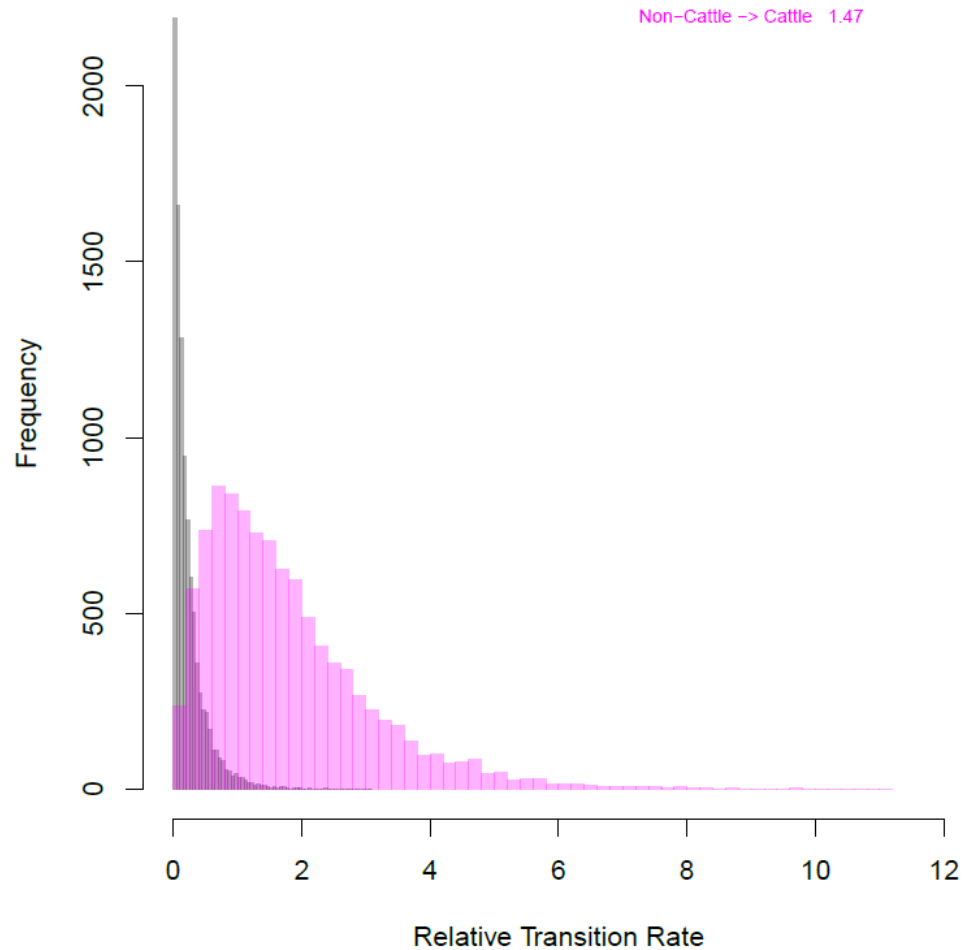

TreeAnnotator v1.8.2

Specify the burnin as the number of states

Burnin (as states):

Specify the burnin as the number of trees

Burnin (as trees):

Posterior probability limit:

Target tree type:

Node heights:

Target Tree File:

Input Tree File:

Output File:

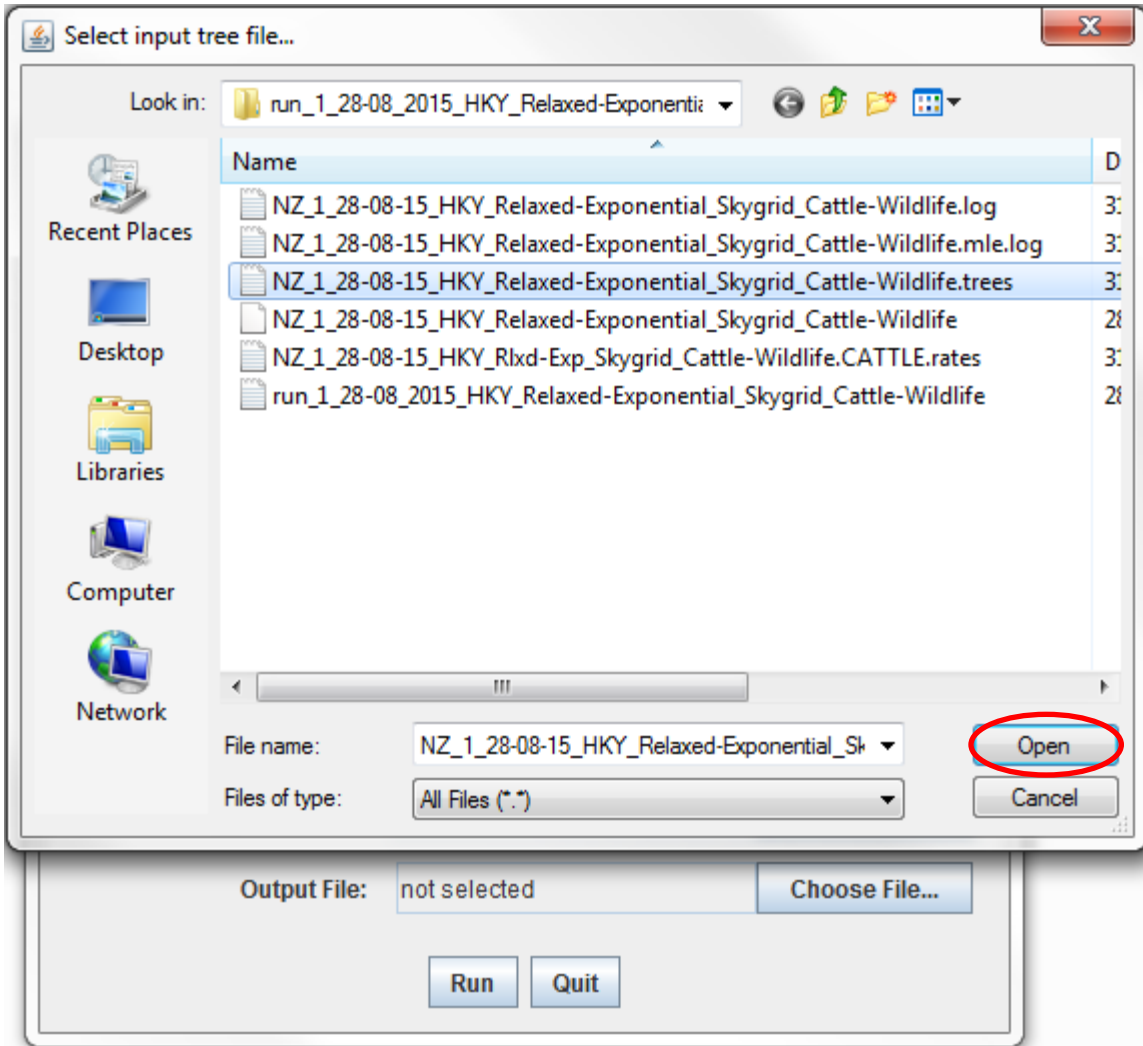

File Edit Tree Help

Cartoon Collapse Reroot Rotate Annotate Colour Highlight Find

Node Clade Taxa

Prev/Next

Filter

Layout

Zoom: Expansion: Fish Eye: Root Length: Curvature: Align Tip Labels

- Current Tree: 1 / 1
- Appearance
- Trees
- Time Scale
- Tip Labels
- Node Labels
- Node Bars
- Node Shapes
- Branch Labels
- Scale Bar
- Scale Axis
- Legend

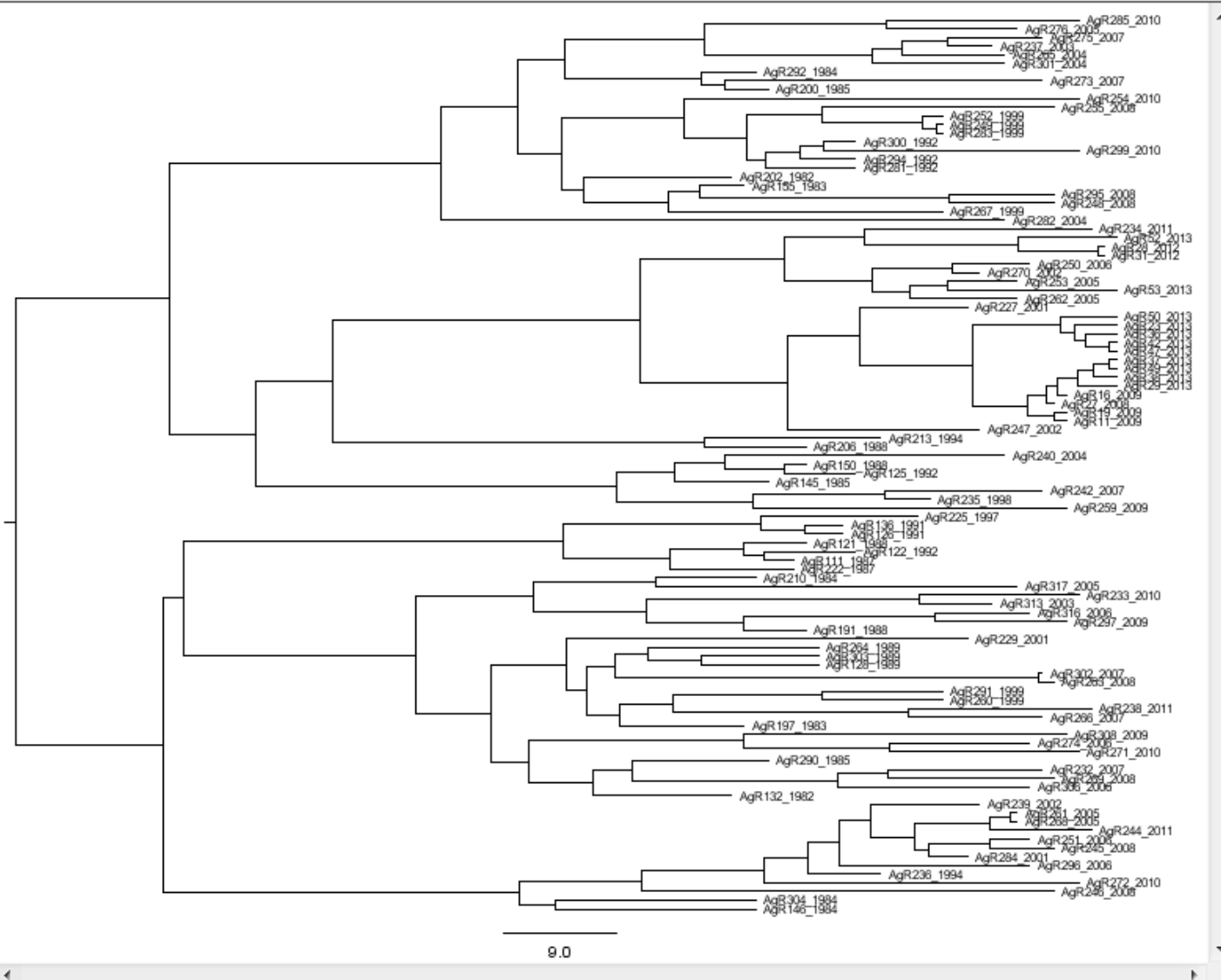

Subtree: 26 tips [height = 63.15, length = 6.193]

NON-BOVINE
BOVINE

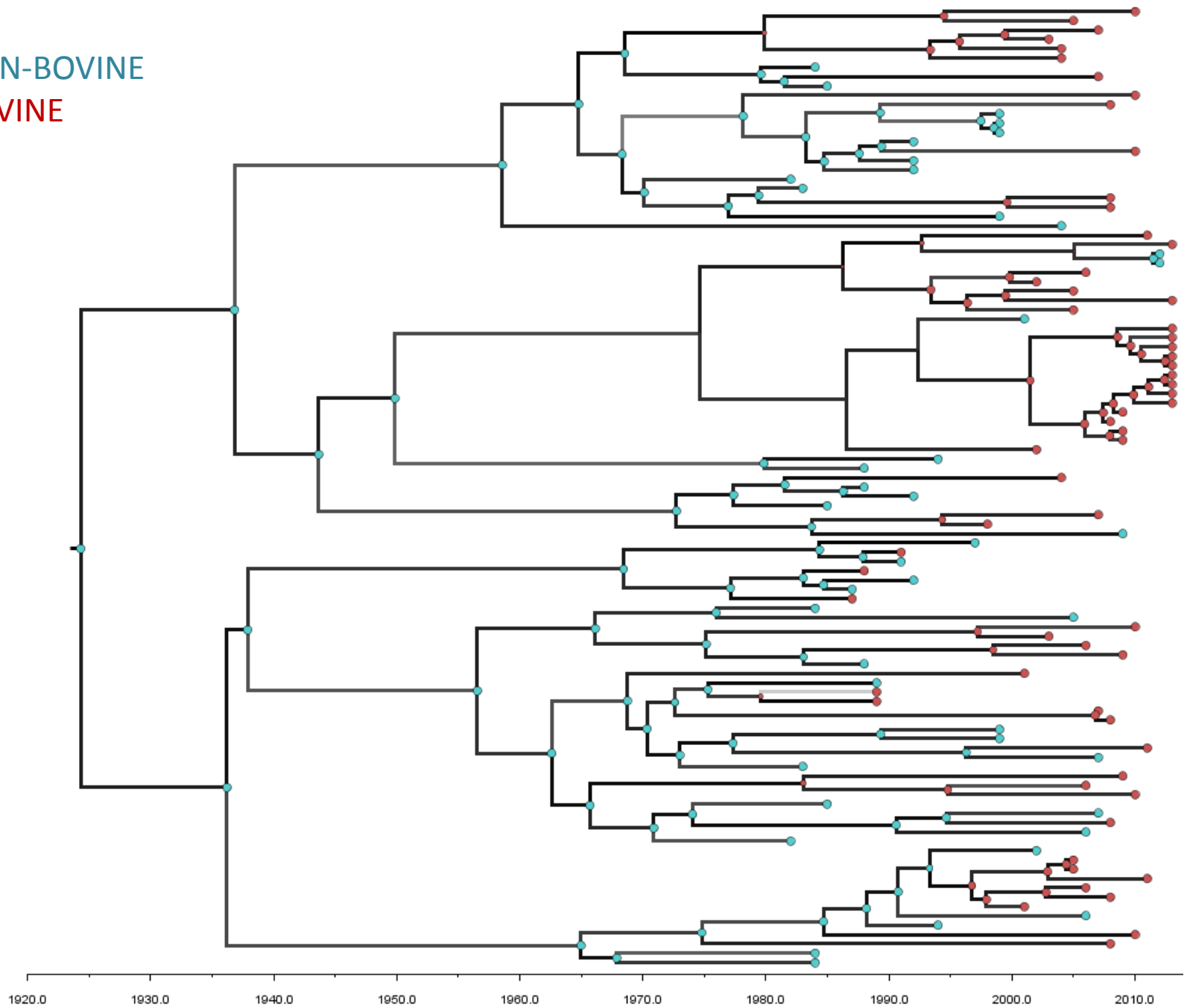

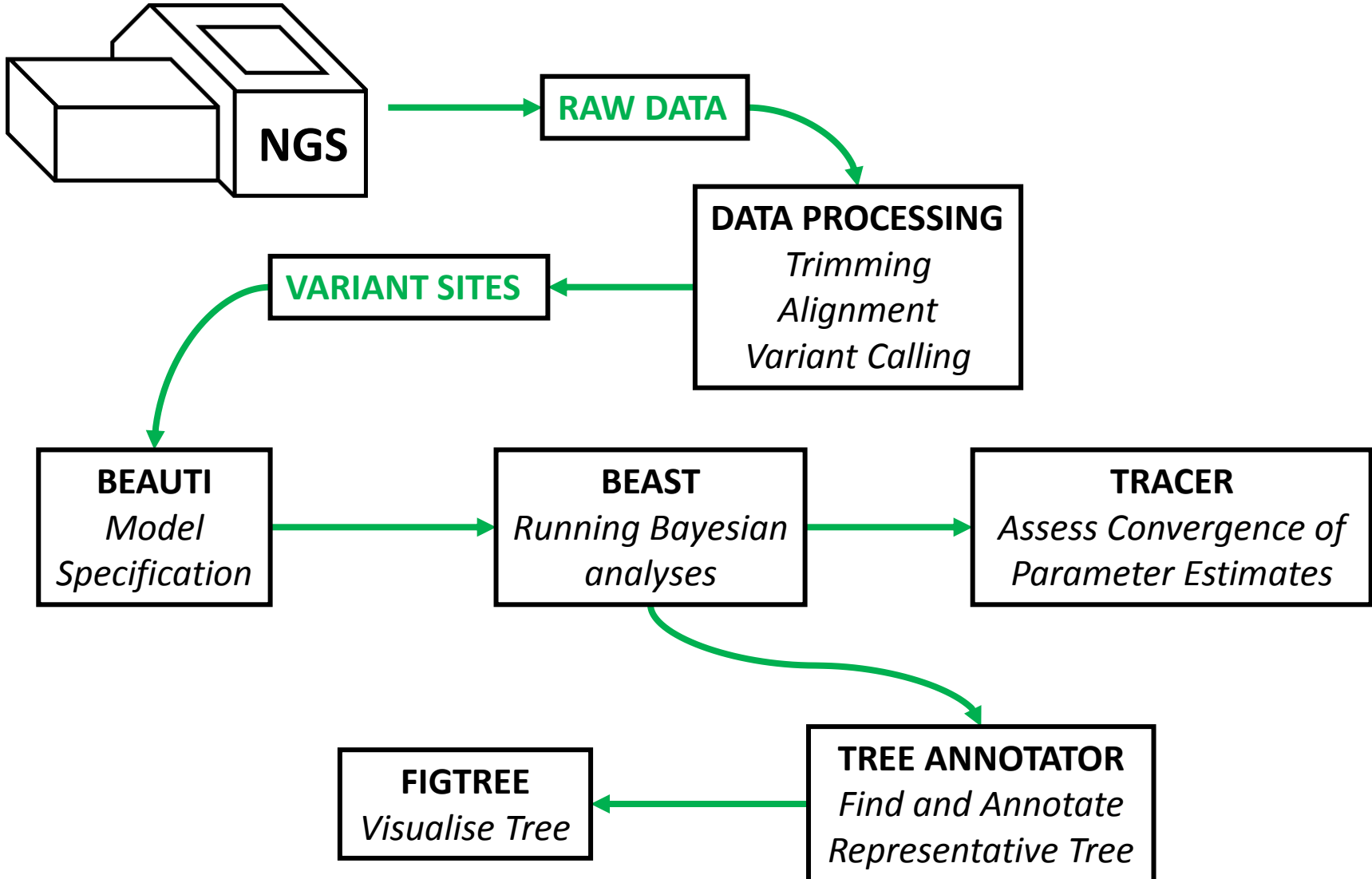

Rowland Kao

Ruth Zadoks



Marian Price-Carter

Paul Livingstone

Maree Joyce

Geoffe de Lisle



Mark Neill

Desmond Collins

Roman Biek

Patrick Brock

Joseph Hughes

Colette Mair

Sibylle Mohr

Nicola Kerbyson

Daniel Balaz

Mikhail Churakov

Liliana Salvador

Sam Lycett

Joanna Morrell

Michael Deason

Thomas Doherty

Thorsten Stefan

Hannah Trewby

Jessica Enright

Mary Parmiter